

**REGULATIONS OF HARRIS COUNTY, TEXAS
FOR THE APPROVAL AND ACCEPTANCE
OF INFRASTRUCTURE**



AS

ADOPTED: DECEMBER 18, 2018

EFFECTIVE: JANUARY 1, 2019

AMENDED JULY 9, 2019

EFFECTIVE JULY 9, 2019

**HARRIS COUNTY
ENGINEERING DEPARTMENT**

**JOHN R. BLOUNT, P.E.
COUNTY ENGINEER**

**LOYD SMITH, P.E.
ASSISTANT COUNTY ENGINEER**

PREFACE

This Regulation is being revised and approved based on the knowledge that the effective Flood Insurance Rate Maps (FIRMs) do not accurately define flood risks because they are based on rainfall information that has since been updated.

The National Oceanic and Atmospheric Administration's (NOAA) Atlas 14 precipitation frequency analysis indicates that the updated 100-year frequency rainfall approximates the current 500-year frequency rainfall. Therefore, this Regulation has been adjusted to reflect that fact.

Upon issuance of the new FIRMs using updated rainfall data as part of the MAAPnext project undertaken by the Harris County Flood Control District and FEMA, and concurrent with their adoption, this Regulation may require adjustments to more accurately regulate flood risks.

TABLE OF CONTENTS

	PAGE
SECTION 1 - PRELIMINARY PROVISIONS	1
Section 1.01 - Authority	1
Section 1.02 - Area Covered by Regulations	1
Section 1.03 - Purpose	1
SECTION 2 - USE OF TERMS	2
Section 2.01 - Accredited Laboratory	2
Section 2.02 - Base Flood.....	2
Section 2.03 - Base Flood Elevation	2
Section 2.04 - Buildable Area.....	2
Section 2.05 - Coastal Areas.....	3
Section 2.06 - Conduit	3
Section 2.07 - County Engineer	4
Section 2.08 - Curb and Gutter Sections	4
Section 2.09 - Design Storm Event	4
Section 2.10 - Drainage Area Map	4
Section 2.11 - Elevation.....	4
Section 2.12- Extreme Event.....	5
Section 2.13 - FEMA	5

Section 2.14 -	Geotechnical Engineer	5
Section 2.14a. -	Floodplain Easement	5
Section 2.15 -	HCFCD	6
Section 2.16 -	Hydraulic Grade Line.....	6
Section 2.17 -	In-Fill Development.....	6
Section 2.18 -	Latent Defects	5
Section 2.19 -	Lot	6
Section 2.20 -	Mean Sea Level.....	6
Section 2.21 -	Person.....	6
Section 2.22 -	Rainfall Frequency	7
Section 2.23 -	Redevelopment.....	7
Section 2.24 -	Residential Lot	7
Section 2.25 -	Roadside Ditch Sections.....	8
Section 2.26 -	Sheet Flow.....	8
Section 2.27 -	Subdivision	8
Section 2.28 -	Substantial Modification	8
Section 2.29 -	Unincorporated Area	9
SECTION 3 -	GENERAL PROVISIONS	10
Section 3.01 -	Administration by the County Engineer	10
Section 3.02 -	Responsibility of Other Officials	10

SECTION 4 -	ADMINISTRATIVE PROCEDURES FOR THE REVIEW OF PLATS	11
Section 4.01 -	Approval Required.....	11
Section 4.02 -	Enforcement.....	11
Section 4.03 -	Plat Criteria	11
Section 4.04 -	Exceptions.....	12
Section 4.05 -	Review Procedures	14
Section 4.06 -	Recordation Requirements.....	15
Section 4.07 -	Floodplain Easements on Plats	19
Section 4.08 -	Certificates Required on Plats of Property Located in the Unincorporated Area of..... Harris County.....	20
Section 4.09 -	Alternative Planning Criteria.....	22
SECTION 5 -	ADMINISTRATIVE PROCEDURES FOR THE REVIEW OF CONSTRUCTION PLANS	24
Section 5.01 -	Submittal Procedures	24
Section 5.02 -	Construction Plans - General	24
Section 5.03 -	Plan Layout Requirements	25
Section 5.04 -	Standard Detail Sheets	26
Section 5.05 -	Standard Note Requirements	26
Section 5.06 -	Supplemental Requirements	27

SECTION 6 -	DRAINAGE REQUIREMENTS	29
Section 6.01 -	Drainage Policy	29
Section 6.02 -	Design Requirements.....	30
Section 6.03 -	Storm Water Detention	46
Section 6.04 -	Ownership and Easements	52
Section 6.05 -	Submerged Storm Sewers	54
Section 6.06 -	Low Impact Development and Green Infrastructure	57
SECTION 7 -	PAVING	58
Section 7.01 -	Paving Design Requirements	58
Section 7.02 -	Design Requirements.....	58
Section 7.03 -	Materials Requirements	65
Section 7.04 -	Specification Requirements	67
Section 7.05 -	Geometric Requirements	69
SECTION 8 -	STRUCTURES AND BENCHMARKS	76
SECTION 9 -	TESTING REQUIREMENTS	78
Section 9.01 -	General	78
Section 9.02 -	Bedding and Backfill.....	78
Section 9.03 -	Subgrade Testing.....	79
Section 9.04 -	Flexible Base	80

Section 9.05 -	Surface Course	80
Section 9.06 -	Concrete Pavement	80
Section 9.07 -	Concrete Cores	81
Section 9.08 -	Structures	81
SECTION 10 -	INSPECTIONS	82
Section 10.01 -	Construction Inspections	82
Section 10.02 -	Notice of Start	82
SECTION 11 -	ACCEPTANCE OF IMPROVEMENTS	83
	WITHIN SUBDIVISIONS	
Section 11.01 -	Acceptance Procedures	83
Section 11.02 -	Inspection and Re-Inspection Fees	86
SECTION 12 -	TRAFFIC	87
Section 12.01 -	Traffic Definitions	87
Section 12.02 -	Left Turn Lanes	87
Section 12.03 -	Roadside Signs	88
SECTION 13 -	LANDSCAPE	88
Section 13.01 -	Landscape Policy	88
Section 13.02 -	Use of Terms	89
Section 13.03 -	Construction Activity	89

Section 13.04 - Prohibited Activity	89
Section 13.05 - Treescape and Screening Requirements for Commercial Establishments and Public Buildings	90
Section 13.06 - Tree Planting Requirements for Single Family Residential Lots.....	92
Section 13.07 - Preservation of Existing Trees.....	93
SECTION 14 - VARIANCES	93
SECTION 15 - VESTED RIGHTS	94
SECTION 16 - VESTED RIGHTS DETERMINATION	96
SECTION 17 - VESTED RIGHTS APPEALS	97
SECTION 18 - VESTED RIGHTS HEARINGS BEFORE THE EXAMINER	97
SECTION 19 - FILING OF EXAMINER'S DECISION ON VESTED RIGHTS APPEALS.....	98
SECTION 20 - REVIEW OF VESTED RIGHTS APPEAL BY COMMISSIONERS COURT	98
SECTION 21 - SEVERABILITY	98

APPENDICES

**Certificates Required on Plats of Property
Located in the Unincorporated Area of Harris CountyA**

Notary Formats B

Graphic Requirements C

Construction Notes to be On All ProjectsD

**Construction Notes Involving
Utilities and Paving Work Located Within a
Public Right-of-Way E**

**Construction Notes for Esplanade
Openings and Turn Lanes F**

**Construction Notes for All Projects Located
in the 1% (100-Year) Floodplain and
.2% (500-Year) FloodplainG**

Intensity Duration Curves H

Joint Detail For: Knuckle ConfigurationI

Benchmark RequirementsJ

Uniform Standards for Public Street NamingK

**REGULATIONS OF HARRIS COUNTY, TEXAS
FOR THE APPROVAL AND ACCEPTANCE OF INFRASTRUCTURE**

SECTION 1 - PRELIMINARY PROVISIONS

SECTION 1.01 - AUTHORITY

These Regulations are adopted by the Commissioners' Court of Harris County, Texas, acting in its capacity as the governing body of Harris County and the Harris County Flood Control District. The authority of Harris County to adopt these Regulations and for the contents hereof is derived from the following statutes: Chapter 232 of the Texas Local Government Code, Texas Local Government Code Section 240.901, as amended; Texas Transportation Code Section 251.001 - 251.05 and Section 254.001 - 254.019, as amended; the Harris County Road Law, as amended, (Special Laws of the 33rd Texas Legislature, Regular Session, 1913, Chapter 17, as amended), and the Flood Control and Insurance Act, as amended. These Regulations may be amended at any time by a majority of Commissioners' Court.

SECTION 1.02 - AREA COVERED BY REGULATIONS

These Regulations apply in all unincorporated areas of Harris County, Texas, and those areas where Harris County maintains the rights-of-way.

SECTION 1.03 - PURPOSE

The purpose of these Regulations is to ensure that the construction of infrastructure within the County's rights-of-way perform their intended function with limited maintenance and repair.

SECTION 2 - USE OF TERMS

SECTION 2.01 - ACCREDITED LABORATORY

An “Accredited Laboratory” is a laboratory that is accredited by the American Association for Laboratory Accreditation (A2LA) or American Association of State Highway and Transportation Officials (AASHTO) in the field of construction materials testing.

SECTION 2.01.a. – ADMINISTRATIVELY COMPLETE

“Administratively Complete” means a completed permit application that is submitted to the County Engineer along with all required fees and includes all the required documents or Plans listed on the Administratively Complete Checklist provided on Harris County Engineering – Permits website. An Administratively Complete permit application is ready for technical review.

SECTION 2.02 - BASE FLOOD

A “Base Flood” is the national standard on which the floodplain management and insurance requirements of the National Flood Insurance Program (NFIP) are based. Special Flood Hazard Areas (SFHAs) are depicted on Federal Emergency Management Agency (FEMA) Flood Insurance Rate Maps (FIRMs) and are areas subject to inundation by the base flood having a one-percent or greater probability of being equaled or exceeded during any given year (this is also known as a 1% or 100-year flood event).

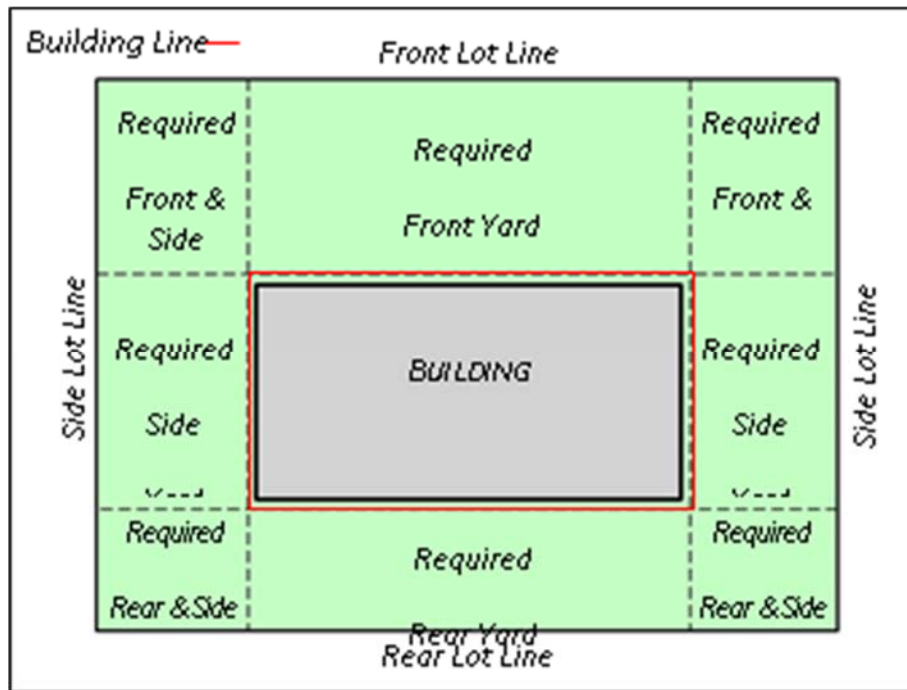
SECTION 2.03 - BASE FLOOD ELEVATION

“Base Flood Elevation” (BFE) means the calculated elevation or level above mean sea level that flood waters may reach during the base flood.

Section 2.04 - BUILDABLE AREA

“Buildable Area” means that portion of a residential lot shown on a final plat upon which a single-family dwelling unit or a multi-family residential structure may be lawfully constructed, located or placed, including a site built home, modular home, manufactured home, duplex, townhouse, or a

multi-unit residential building, in accordance with applicable building restriction lines, covenants, plat notations, and setbacks, if any.



**Buildable Area Graphic*

SECTION 2.05 - COASTAL AREAS

“Coastal Areas” means areas which border on bays or estuaries or other waterways subject to tidal action which are subject to possible flooding or increased flood levels because of tidal action, hurricane surge or rising water due to storms, hurricanes or tsunamis. A “coastal area” is not necessarily in a “V” Zone. In cases where there is a question as to whether an area is a coastal area, the Harris County Engineering Department shall refer to the FEMA Flood Insurance Study.

SECTION 2.06 - CONDUIT

A “Conduit” is any open or closed device for conveying flowing water.

SECTION 2.07 - COUNTY ENGINEER

“County Engineer” means the holder of the statutory position of the County Engineer for Harris County or the employee designated by the County Engineer to perform a task required by these Regulations.

SECTION 2.08 - CURB AND GUTTER SECTIONS

A “Curb and Gutter Section” is a full width concrete pavement with curb, either doweled on six-inch (6”) curbs or doweled four-inch (4”) by twelve-inch (12”) curb or monolithic curb and gutter sections for asphalt concrete pavement.

SECTION 2.09 - DESIGN STORM EVENT

“Design Storm Event” means the rainfall intensity upon which the drainage facility will be sized. References to rainfall conditions in these specifications shall apply to “Technical Paper No. 40, U. S. Weather Bureau”, published by the U. S. Department of Agriculture, Soil Conservation Service.

SECTION 2.10 - DRAINAGE AREA MAP

“Drainage Area Map” means the area map of a watershed, which is subdivided to show the area served by each subsystem.

SECTION 2.11 - ELEVATION

“Elevation” means height above mean sea level. The North American Vertical Datum (NAVD) of 1988 (2001 Adjusted) shall be used. Any future studies changing the Flood Insurance Rate Map (FIRM), which is referenced to a later re-leveling of the vertical control system shall be used whenever a revised FIRM becomes effective.

SECTION 2.12 - EXTREME EVENT

“Extreme Event” means a rainfall event, which exceeds the Design Storm Event up-to and including the 100-year frequency resulting in surcharge of the underground storm sewer system and overland sheet flow.

SECTION 2.13 - FEMA

“FEMA” means the Federal Emergency Management Agency.

SECTION 2.14.a. – FLOODPLAIN EASEMENT

“Floodplain Easement” means the area of a residential lot shown on a final plat that is within the 100-year floodplain as determined by the current Flood Insurance Rate Map (FIRM). The Floodplain Easement will provide notice that the residential lot is subject to special development and permitting requirements by local governments implementing flood hazard area regulations as part of a flood management program developed in compliance with the National Flood Insurance Program or Texas Water Code Section 16.315. The Floodplain Easement encumbers that portion of a “residential lot” that may be used for residential purposes which may be flood prone or in a flood hazard area based on the current FIRM. Improvements constructed or placed in a Floodplain Easement, including single-family and multi-family dwelling units, may be subject to additional floodplain management regulations.”

SECTION 2.14 - GEOTECHNICAL ENGINEER

A “Geotechnical Engineer” is a licensed engineer within the State of Texas who works for a company registered in the State of Texas that has been accredited by the American Association for Laboratory Accreditation (A2LA) in geotechnical testing.

SECTION 2.15 - HCFCD

“HCFCD” means the Harris County Flood Control District.

SECTION 2.16 - HYDRAULIC GRADE LINE

“Hydraulic Grade Line” means the line representing the pressure head available at any given point within the drainage system.

SECTION 2.17 - IN-FILL DEVELOPMENT

“In-fill Development” means the development of open tracts of land in areas where the storm drainage infrastructure is already in place and takes advantage of the existing infrastructure as a drainage outlet.

SECTION 2.18- LATENT DEFECTS

“Latent Defects” means a defect or condition of construction which does not comply with the construction documents or designs intent which is generally a hidden or concealed defect which cannot be discovered by reasonable or customary inspection, examination or observation at either the time of construction or substantial completion, but which manifests over time.

SECTION 2.19 - LOT

For the purpose of these regulations the term Lot means any platted lot, parcel, or reserve.

SECTION 2.20 - MEAN SEA LEVEL

“Mean Sea Level” means the average height of the surface of the sea for all states of the tide as was established by the United States Coastal and Geodetic Survey in 1929.

SECTION 2.21 - PERSON

“Person” includes any individual or group of individuals, corporation, partnership, association, or any other organized group of persons, including State and Local governments and agencies thereof.

SECTION 2.22 - RAINFALL FREQUENCY

“Rainfall Frequency” means the probability of a rainfall event of defined characteristics occurring in any given year. Information on rainfall frequency is published by the National Weather Service. For the purpose of storm drainage design, the following frequencies are applicable:

1. 2-year frequency – a rainfall intensity having a 50% probability of occurrence in any given year, or nominally likely to occur once every two years.
2. 3-year frequency – a rainfall intensity having a 33% probability of occurrence in any given year, or nominally likely to occur once every three years.
3. 5-year frequency – a rainfall intensity having a 20% probability of occurrence in any given year, or nominally likely to occur once every five years.
4. 10-year frequency – a rainfall intensity having a 10% probability of occurrence in any given year, or nominally likely to occur once every ten years.
5. 25-year frequency – a rainfall intensity having a 4% probability of occurrence in any given year, or nominally likely to occur once every twenty-five years.
6. 100-year frequency – a rainfall intensity having a 1% probability of occurrence in any given year, or nominally likely to occur once every one hundred years.
7. 500-year frequency – a rainfall intensity having a 0.2% probability of occurrence in any given year, or nominally likely to occur once every five hundred years.

SECTION 2.23 - REDEVELOPMENT

“Redevelopment” means a change in land use that alters the impervious cover from one type of development to either the same type or another type and takes advantage of the existing infrastructure in place as a drainage outlet.

Section 2.24 - RESIDENTIAL LOT

“Residential lot” means a lot, parcel or reserve within a subdivision on which a single-family dwelling unit or a multi-family residential structure may be lawfully constructed, located or placed, including a site built home, modular home, manufactured home, townhouse, duplex or a multi-unit residential building.

SECTION 2.25 - ROADSIDE DITCH SECTIONS

“Roadside Ditch Sections” are ditch sections adjacent to either full width reinforced concrete pavement or asphaltic concrete pavement.

SECTION 2.26 - SHEET FLOW

“Sheet Flow” means the overland storm runoff that is not conveyed in a defined conduit and is typically in excess of the capacity of the conduit or roadside ditch.

SECTION 2.27 - SUBDIVISION

“Subdivision” means a division of any tract of land into two (2) or more parts for the purpose of laying out any subdivision or any tract of land or any addition to the city, or for laying out suburban lots or buildings lots, or any lots, and streets, alleys or parts of other portions intended for public use or the use of the purchasers or owners of lots fronting thereon or adjacent thereto. A subdivision includes re-subdivision (replat), but it does not include the division of land in parcels or tracts of ten (10) acres or more and not involving any new streets, alleys or easements of access. This definition is based on current state statutes and should the statutes be changed its new definition would govern.

SECTION 2.28 -SUBSTANTIAL MODIFICATION

Substantial modification shall mean changes to the approved plans, plat, and/or drainage report or change of use that will increase impervious cover, or the volume and/or peak discharge of the stormwater runoff from portions of, or the whole of the project or any other change that would affect the volume or peak discharge of stormwater runoff that would cause adverse impacts to off-site properties.

SECTION 2.29 - UNINCORPORATED AREA

“Unincorporated Area” means the area in Harris County, Texas, which is not within an incorporated area of a city, town, and village or within the “jurisdiction of the Port of Houston Authority of Harris County, Texas,” being that area within 2,500 feet of the thread of the Houston Ship Channel that is eligible for limited purpose annexation pursuant to Texas Local Government Code §43.136.

SECTION 3 - GENERAL PROVISIONS

SECTION 3.01 - ADMINISTRATION BY THE COUNTY ENGINEER

The County Engineer is responsible for the administration of these Regulations, approval of plans required by these Regulations, and enforcement of these Regulations and maintaining proper records. The County Engineer may delegate particular authority given to the County Engineer under these Regulations to another member of the Harris County Engineering Department and an action by such delegated person under such granted authority shall be deemed an action of the County Engineer.

SECTION 3.02 - RESPONSIBILITY OF OTHER OFFICIALS

Under these regulations the Harris County Engineering Department is responsible for all administrative decisions, determinations and duties. The Harris County Engineering Department may seek and secure the assistance of other officials of Harris County and of the Harris County Flood Control District in making its decisions, determinations and in performing duties but is not required to conform to the recommendations of others.

SECTION 4 - ADMINISTRATIVE PROCEDURES FOR THE REVIEW OF PLATS

SECTION 4.01 - APPROVAL REQUIRED

All development within the unincorporated areas of Harris County is prohibited without first securing approved plans or plat, if required, and a development permit issued under the Regulations of Harris County, Texas, for Floodplain Management.

SECTION 4.02 - ENFORCEMENT

It shall be unlawful for any person to lay out, subdivide or plat any land into lots, blocks, tracts or streets within the unincorporated area of Harris County if the land has not been laid out, subdivided and platted in accordance with these rules and regulations.

SECTION 4.03 - PLAT CRITERIA

For tracts of land located within the extraterritorial jurisdiction (ETJ) of an incorporated city or town and subject to the jurisdiction of the Planning Commission or other **governing body** of that city or town, general subdivision and layout requirements as established by the applicable Commission or other **governing body** shall apply. In the circumstance where any rule, regulation, procedure or policy lawfully or officially adopted by the governing body of any city or town exercising jurisdiction within its extraterritorial jurisdiction is less restrictive than that contained herein, the standards adopted by these rules and regulations and applicable State law shall apply.

For all other tracts not located within a municipality's extraterritorial jurisdiction or for which the municipality has issued a written certification stating that a plat is not required to be filed for that subdivision of land in accordance with Chapter 212 of the Texas Local Government Code, the following rules and design requirements shall apply:

1. Lots shall be of sufficient acreage to meet minimum requirements for on-site sewage service per TCEQ Chapter 285.4 Facility Planning regulations, unless served by public water and/or sewage.

2. Public road rights-of-way shall be a minimum fifty feet (50') in width and in conformance with the Geometric Design Guidelines as adopted by Harris County Commissioners' Court.
3. A building setback line of not less than twenty-five feet (25') from the road right-of-way shall be imposed on tracts intended for construction of a single-family structure or structures. However, twenty-foot (20') building setback lines will be permitted for single-family residential lots on cul-de-sacs and knuckles. A ten-foot (10') building setback line will be permitted on side lots of single-family residential lots. A building setback line of no less than ten feet (10') shall be imposed on all other tracts. These setbacks may be modified if such modifications comply with County Planning Criteria.
4. Construction of road and appurtenant drainage facilities shall be in conformance with specifications as set out in these rules and regulations.
5. Surveyor shall delineate the limits of the 100-year floodplain on a final plat and designate a Floodplain Easement on that portion of all residential lots where the buildable area is within the 100-year floodplain.
6. Financial Surety: A cash deposit, bond, or letter of credit made in accordance with the Texas Local Government Code ↓232.004 or ↓232.0045 and these regulations.

For all tracts not located within a municipality's extraterritorial jurisdiction, thoroughfare alignment and right-of-way (ROW) width planning shall follow the requirements specified in the Thoroughfare Amendment Study for Unincorporated and Non-ETJ Areas of Harris County, Texas as adopted by Harris County Commissioners' Court and any subsequent revisions thereto.

SECTION 4.04 - EXCEPTIONS

Exceptions to platting requirements are established in Section 232.0015 of the Texas Local Government Code. A brief description follows:

1. A county may not require the owner of a tract of land located outside the limits of a municipality who divides the tract into two or more parts to have a plat of the subdivision prepared if the owner does not lay out a part of the tract as streets, alleys, squares, parks, or other parts of the

tract to be dedicated to public use or for use of lots fronting on or adjacent to the streets, alleys, squares, or other parts, and the land is to be used primarily for agricultural use or farm, ranch, wildlife management, or timber production.

2. A county may not require the owner of a tract of land located outside the limits of a municipality who divides the tract of land into four or fewer parts and does not lay out a part of the tract as streets, alleys, squares, parks, or other parts of the tract to be dedicated to public use or for use of lots fronting on or adjacent to the streets, alleys, squares, or other parts to have a plat of the subdivision prepared if each of the lots is to be sold, given, or otherwise transferred to an individual who is related to the owner within the third degree by consanguinity or affinity per Chapter 573, Government Code. If the tract is transferred to another who is not related within the third degree by consanguinity or affinity, then the platting requirements of these regulation shall apply.
3. A county may not require the owner of a tract of land located outside the limits of a municipality who divides the tract into two or more parts to have a plat of the subdivision prepared if all the lots of the subdivision are more than 10 acres in area and the owner does not lay out a part of the tract as streets, alleys, squares, parks, or other parts of the tract to be dedicated to public use or for use of lots fronting on or adjacent to the streets, alleys, squares, or other parts.
4. A county may not require the owner of a tract of land located outside a municipality to have a plat of the subdivision prepared if all the lots are sold to veterans through the Veterans' Land Board program.
5. A county may not require the owner of a tract land to have a plat prepared if the owner is the state or any state agency, board, or commission or owned by the permanent school funds of the state unless the subdivision lays out a part of the tract as streets, alleys, squares, parks, or other parts of the tract to be dedicated to public use or for use of lots fronting on or adjacent to the streets, alleys, squares, or other parts.
6. A county may not require the owner of a tract of land located outside the limits of a municipality who divides the tract into two or more parts to have a plat of the subdivision prepared if the owner of the land is a political subdivision of the state, the land is situated in the floodplain, and the lots are sold to adjoining landowners.

7. A county may not require the owner of a tract of land outside the limits of a municipality who divides the tract into two parts to have a plat of the subdivision prepared if the owner does not lay out a part as streets, alleys, squares, parks, or other parts of the tract to be dedicated to public use or for use of lots fronting on or adjacent to the streets, alleys, squares, or other parts and one part is to be retained by the owner, and the other new part is to be transferred to another person who will further subdivide the tract subject to the plat approval requirements.
8. A county may not require the owner of a tract of land located outside the limits of a municipality who divides the tract into two or more parts to have a plat of the subdivision prepared if the owner does not lay out a part of the tract as streets, alleys, squares, parks, or other parts of the tract to be dedicated to public use or for use of lots fronting on or adjacent to the streets, alleys, squares, or other parts and all parts are transferred to persons who owned an undivided interest in the original tract and a plat is filed before any further development of any part of the tract.

SECTION 4.05 - REVIEW PROCEDURES

Municipalities in Harris County exercising their extraterritorial jurisdiction (“ETJ”) in the unincorporated area of Harris County have developed specific and unique procedures in processing plats. The procedures outlined below shall be followed for submitting a plat application and plat to a municipality and Harris County for review and comment. Procedures for submitting a plat application and plat for property located in the unincorporated area of Harris County are also included below. For all plats within a municipality’s ETJ, use the dedicatory language as promulgated by that municipality. For plats not located in a municipality’s ETJ, required dedicatory language and all plat certificate requirements are set forth in Section 4.07 and in Appendix “A” respectively.

Plats Within A Municipality’s ETJ. For plats of property located in the unincorporated area of Harris County and the ETJ of a municipality, the owner of the tract being platted shall submit copies of the plat, along with a plat application, to the municipality exercising ETJ for review and comments, at which time the municipality may begin its review of the plat. It shall be the responsibility of the owner of the tract being platted to ensure that the

Harris County Engineering Department and the Harris County Flood Control District also receive copies of the plat.

Plats Not Located in a Municipality's Extraterritorial Jurisdiction. For plats of property located exclusively in the unincorporated area of Harris County and not in the extraterritorial jurisdiction of any municipality, the owner of the tract being platted shall simultaneously submit copies of the plat application and the plat to the Harris County Engineering Department and the Harris County Flood Control District, at which time they will begin their review of the plat.

All Plats. Upon Harris County Engineering Department's receipt of the original mylar of the plat fully executed by the owners and, as applicable, approved by the appropriate Planning Commission or governing body, along with the required documentation described in "Recordation Requirements" in Section 4.06 below, Harris County Engineering Department will begin its review of the plat.

If the plat does not meet all the requirements of Section 4 of these Regulations, the Harris County Engineering Department will provide its comments to the owner of the tract being platted in accordance with Section 232.0025 of the Texas Local Government Code. If the plat meets all the requirements set forth in Section 4 of these Regulations, the Harris County Engineer will sign it. The plat will then be placed on the next available Commissioners' Court agenda for approval.

Once approved by Harris County Commissioners Court ("Court"), the Court will send the plat to the office of the Harris County Clerk for recordation. The Harris County Clerk shall calculate the required recording fees and notify the applicant or applicant's designee of same. Upon receipt of such fees, the plat will be filed and recorded in the Official Public Records of Real Property and Map Records of Harris County, Texas.

SECTION 4.06 - RECORDATION REQUIREMENTS

The following documentation is required to be submitted along with the original mylar of the plat that is to be reviewed by the Harris County Engineering Department, submitted to Harris County Commissioners' Court for approval, and filed with the Harris County Clerk. Harris County will accept for recordation only those plats printed on the front side of the mylar or other reproducible material.

1. A title report, or opinion, title policy or certificate or letter from a title company authorized to do business in the State of Texas must be provided indicating ownership of the property, all liens against same, and any existing easements. The title report shall not have been executed more than sixty (60) days prior to the time the final plat is received by the Harris County Engineering Department and may require updating at the request of Harris County personnel. Owners of property located within the plat must either sign the plat or execute an Owner's Ratification of Plat document, as promulgated by the County Engineer. Furthermore, liens against the property shall be subordinate to all dedication of streets, rights-of-ways, easements and terms and conditions referred to on the plat. Lienholders must either sign the plat or execute a Lienholder's Subordination to Dedication document as promulgated by the Harris County Engineer. See Appendix "B" for notary formats.

2. An original tax certificate from the tax collector of each political subdivision in which the property is located showing that all taxes owed to the County, School District, Utility District, and/or any other political subdivision have been paid in full. If the plat or replat is filed after September 1 of a year, the plat or replat must also have attached to it a tax receipt issued by the collector for each taxing unit with jurisdiction of the property indicating that the taxes imposed by the taxing unit for the current year have been paid or, if the taxes for the current year have not been calculated, a statement from the collector for the taxing unit indicating that the taxes to be imposed by that taxing unit for the current year have not been calculated. If the tax certificate for a taxing unit does not cover the preceding year, the plat or replat must also have attached to it a tax receipt issued by the collector for the taxing unit indicating that the taxes imposed by the taxing unit for the preceding year have been paid in full.

This requirement does not apply to the extent of the applicability of exceptions in Texas Property Code ↓ 12.002(e) in regard to certain real property acquired by will or inheritance or to certain property acquired by eminent domain.

3. A completed Utility Service Plan, as promulgated by the County Engineer, shall be submitted. In no case shall a plat be recorded prior to assurances being given that all applicable State and County reviews and/or permit(s) have been obtained.

4. A letter from the County Tax Assessor-Collector certifying that the name of the subdivision to be presented to Commissioners' Court is not in conflict with any other previously recorded subdivision. This requirement applies to the first section of multi-section subdivisions, all re-plats, and amending plats and is not applicable to street dedication plats designated by a street name.
5. Approved plans are to be on file with the Engineering Department at the time the plat is submitted to Commissioners' Court. However, if the tract of land is being platted to create reserves for the purpose of sale only and there are no immediate plans for construction of improvements on said reserves, then a note shall be placed on the face of the plat stating:

“Site drainage plans for the future development of this reserve must be submitted to the Harris County Flood Control District and the Harris County Engineering Department.”
6. A letter, statement or other instrument from the owner of any privately owned easement within the plat boundaries where such easement is to be crossed by streets (either public or private) or public utility or drainage easements, stating that the owner of such easement approves such crossing of the private easement for the purposes intended and depicted on the plat, if such approval is not granted in the original document conveying the easement.
7. A plat review fee as established by Commissioners' Court is required to be submitted.
8. For plats of lots and/or reserves requiring plan review and not dedicating any public rights-of-way, a non-refundable administrative fee is assessed in the amount of \$10.00 per lot. Reserves are assessed a non-refundable administrative fee of \$20.00 per 100 feet of plat boundary adjoining road right-of-way rounded to the next highest increment of \$20.00. Payment of administrative fees should be made payable to Harris County and are due prior to the plat being promoted to Commissioners' Court for action. Payment of administrative fees must be submitted with the Financial Surety/Administrative Worksheet validated by the Planning Section.

9. For plats proposing the dedication of a public street(s) and construction of paving and appurtenant drainage, a Financial Surety is required prior to plat approval and shall be:
 - A. Made payable to Harris County, unless cash; and
 - B. In a total amount based upon the following schedule:

RESIDENTIAL SUBDIVISIONS	COMMERCIAL AND STREET DEDICATION SUBDIVISIONS
\$50 per lot with average road frontage less than 100 feet.	\$75 per 100 feet of proposed pavement. The fee shall be rounded to the next 100 feet.
\$75 per lot with average road frontage 100 feet or greater.	
* NOTE: The minimum financial surety posted in any case shall be \$2,500.00. Included is the non-refundable administrative fee of \$10 per lot for residential subdivisions-or \$20 per 100 ft. of pavement in commercial and street dedication subdivisions.	

10. For properties being platted in the unincorporated areas of Harris County, where there is not Extraterritorial Jurisdiction being exercised for water and sewer facilities, the following requirements for water and sewage facilities apply:
 - A. The drinking water supply shall meet the minimum requirements established by Chapter 341 of the Health and Safety Code and any other minimum requirements established by the Texas Commission on Environmental Quality applicable to drinking water.
 - B. Any onsite sewerage disposal systems shall be constructed in accordance with Chapter 366 of the Health and Safety Code and the Revised Rules of Harris County for On-Site Sewerage Facilities.

- C. Any sewerage facility other than a properly permitted onsite sewage facility shall be constructed and operated under a valid permit issued by the Texas Commission on Environmental Quality.
- 11. If a property lies within the 100-year floodplain as shown on the most recent FIRM adopted by Harris County, the floodplain must be delineated graphically on the final plat. Surveyor shall designate a Floodplain Easement on that portion of all residential lots where the buildable area of those residential lots is within the 100-year floodplain. Refer to Section 4.08 for floodplain easement dedicatory language.
- 12. Additional information may be required by the Engineering Department to clarify or support any of the aforementioned recordation requirements.

SECTION 4.07 – FLOODPLAIN EASEMENTS ON PLATS

Where the buildable area of a lot, parcel or reserve is intended for single family or multi-family residential units and is proposed to be placed within the mapped 100-year floodplain, the final plat shall show that portion of the 100-year floodplain as a “Floodplain Easement” on the plat. The Floodplain Easement shall be illustrated on the final plat map as congruent with the limits of the 100-year floodplain within the plat boundary from the most recent FIRM and shall be included as a dedication by the property owner using the language below.

1) Sample Floodplain Easement

”A Floodplain Easement is hereby established over that portion of the effective 100-year floodplain area as delineated from FIRM PANEL No. XXXX dated XXXX within the boundary of this final plat, the limits of which impact the buildable areas of residential lots, wholly or partially, and within such area is prone to flooding. (*See attached sketch.) Construction of any type of residential housing within a Floodplain Easement is subject to additional flood hazard area regulations. A Floodplain Easement may be abandoned by Harris County Commissioners Court if the buildable area of a residential lot is determined to be outside the 100-year floodplain by submitting County Engineer’s Form 1226, with the applicable documentation and fee, to the Office of the County Engineer.

2) Abandonment of Floodplain Easement

A Floodplain Easement may be abandoned by using following procedure:

- a) Complete Harris County Engineer Form 1226 including providing proof that the buildable area of a specific residential lot(s) has been removed from the mapped 100-year floodplain by a letter of map revision (LOMR) or a letter of map amendment (LOMA).
- b) Submit the applicable fee, to be the same as a permit for a single family residence outside the floodplain, currently \$75.00.
- c) Once received, reviewed and approved by the Office of the County Engineer, a Court Order will be submitted to Commissioners Court, abandoning the Floodplain Easement on the residential lot(s).
- d) Once approved by Commissioners Court the County Engineer will file the abandonment in the Real Property Records of Harris County.

SECTION 4.08 - DEDICATORY LANGUAGE AND CERTIFICATES REQUIRED ON PLATS OF PROPERTY LOCATED IN THE UNINCORPORATED AREA OF HARRIS COUNTY

1. Dedicatory language on the plats must include the following paragraphs and can be found in Appendix “A” to these regulations:

- A. “FURTHER, Owners do hereby dedicate to the public a strip of land fifteen (15) feet wide on each side of the center line of any and all bayous, creeks, gullies, ravines, draws, sloughs, or other natural drainage courses located in said plat, as easements for drainage purposes, giving the City of (name of city), Harris County, or any other governmental agency, the right to enter upon said easement at any and all times for the purpose of construction and maintenance of drainage facilities and structures.”;
- B. “FURTHER, Owners do hereby covenant and agree that all of the property within the boundaries of this plat and adjacent to any drainage easement, ditch, gully, creek or natural drainage ways shall hereby be restricted to keep such drainage ways and

easements clear of fences, buildings, planting and other obstructions to the operations and maintenance of the drainage facility and that such abutting property shall not be permitted to drain directly into this easement except by means of an approved drainage structure.”; and

- C. “FURTHER, Owners certify and covenant that they have complied with or will comply with existing Harris County Road Law, Section 31-C as amended by Chapter 614, Acts of 1973, 63rd Legislature and all other regulations heretofore on file with the Harris County Engineer and adopted by the Commissioners’ Court of Harris County.”

2. Additional certification on the plat must indicate the floodplain status of the buildable areas on “residential lots” on the plat, referring to the applicable Flood Insurance Rate Map panel and effective date.

- A. Buildable Areas Outside the Floodplain:

“I, _____, a Registered Professional Licensed Surveyor in the State of Texas, do hereby certify that the buildable areas for all residential lots are outside [or, are proposed to be outside, based on engineering plans and specifications submitted to the County Engineers Office,] the 100-Year Floodplain as shown on Federal Insurance Rate Map Panel No. [insert panel number] dated [insert effective date of map]. This certification is based solely on plotting boundaries from the FIRM Map, and no technical analysis was conducted.”

- B. Buildable Areas in the Floodplain

“I, _____ a Registered Professional Licensed Surveyor in the State of Texas, do hereby certify that the buildable areas for all or some of the residential lots are located within the 100-year floodplain as plotted from the Federal Insurance Rate Map Panel No. [insert panel number] dated [insert effective date of map] and are subject to flooding. The 100-year floodplain is a flood hazard area prone to flooding, and subject to additional floodplain management regulations.”

3. Floodplain easement dedicatory language must be shown on the plat if a Floodplain Easement is required in accordance with Section 4.07 Floodplain Easements.

”A Floodplain Easement is hereby established over that portion of the effective 100-year floodplain area as delineated from FIRM PANEL No. XXXX dated XXXX within the boundary of this final plat, the limits of which impact the buildable areas of residential lots, wholly or partially, and within such area is prone to flooding. (*See attached sketch.) Construction of any type of residential housing within a Floodplain Easement is subject to additional flood hazard area regulations. A Floodplain Easement may be abandoned by Harris County Commissioners Court if the buildable area of a residential lot is determined to be outside the 100-year floodplain by submitting County Engineer’s Form 1226, with the applicable documentation and fee, to the Office of the County Engineer.

4. Approved Certificate Language may be found in Appendix “A” to these regulations.

SECTION 4.09 – Alternative Planning Criteria

Harris County Alternate Planning Criteria for Subdivisions and Platting shall be adhered to when more stringent than municipality whose extraterritorial jurisdiction includes any part of unincorporated Harris County. Chapter 42-Section 3 of the City of Houston’s Ordinance codifies this requirement; however, the County Planning Criteria applies to all city’s ETJ areas.

Projects following the below County Planning Criteria, are deemed to be more stringent and said criteria supersedes criteria of any City’s ETJ requirement. To prevent confusion, any plat using the County’s more stringent criteria, will be reviewed by the County first, and if found to meet the County Criteria, a letter will be issued by the County Engineer stating that fact for use by the respective City.

County Planning Criteria
(These pages left intentionally blank)

SECTION 5 - ADMINISTRATIVE PROCEDURES FOR THE REVIEW OF CONSTRUCTION PLANS

SECTION 5.01 - SUBMITTAL PROCEDURES

1. A preliminary set of plans shall be submitted to the County Engineer for review along with a County issued Routing Slip. Upon review, the Plans will be returned to the consultant with any necessary comments. Plans may be reviewed electronically by submitting through the online system using the appropriate application.
2. Upon addressing all the comments, a final review will be conducted by submitting the marked-up preliminary set, a reproducible set, and the routing slip to the County Engineer. The plans will be approved or additional comments will be made and the sets returned.

SECTION 5.02 - CONSTRUCTION PLANS - GENERAL

For all construction plans submitted to the Harris County Engineering Department pursuant to these regulations, the following requirements shall apply:

1. A Professional Engineer, licensed in the State of Texas, is required to seal, date and sign each sheet of the plans in accordance with rules set forth by the Texas State Board for Professional Engineers. The seal must reproduce on all sheets.
2. A cover sheet shall be required for all projects involving three or more plan and profile sheets. All plan sheet numbers should be included on the cover sheet or area map. A vicinity map should always be included to show the project location.
3. Plans for street and/or public improvements shall be standard twenty-two inch by thirty-four inch (22" x 34") overall dimensions for all design in rights-of-way or easements. Site plans may be submitted on larger sheets when practical.
4. Plans submitted for Harris County Engineering Department approval shall be on a reproducible material.

5. A North arrow is required on all sheets and should be generally oriented either upward or to the right.
6. All projects shall be tied to the datum adjustment that matches the FIRMs or the most current datum available in coastal areas. Equations may be used to translate other datum adjustments to the required adjustment.
7. Graphic standards for construction plans submitted shall be in accordance with those outlined in Appendix "C" to these regulations.
8. If the property lies below the base flood level, the floodplain must be delineated graphically on all plan sheets.

SECTION 5.03 - PLAN LAYOUT REQUIREMENTS

Plans submitted to the Harris County Engineering Department pursuant to these regulations shall have the following items:

1. General construction layouts shall be submitted for all paving and utility projects involving more than three plan and profile sheets. For the purpose of fulfilling this requirement, paving and drainage layouts may be combined and water and sanitary sewer layouts may be combined.
2. A drainage area map shall be submitted and shall include drainage computations with drainage area and storm water flow labeled.
3. A lot grading plan shall be submitted for residential lots on which earthwork is proposed that will change the natural topography.
4. A drawing showing existing natural contours at one-foot (1') intervals of the land to be developed.
5. A graphical sheet index shall be included on the general construction layout or on a separate index sheet showing the plan and profile sheet location and sheet number.
6. Match lines in appropriate locations and not in the intersections of two streets or cul-de-sac knuckles shall be provided.
7. If a roadway exists where plans are being prepared to improve the

roadway or construct new pavement or to construct a utility, this roadway should be labeled as to its existing width, type of surfacing and base thickness if available without destruction of pavement.

8. All improvements shall be labeled as “Proposed” or “Existing” in both Plan and Profile Views.
9. Include a fire lane designed in accordance with the current Harris County Fire Code for approval with all commercial site plans.
10. Include a landscape plan designed in accordance with these regulations for approval with all commercial site plans.

SECTION 5.04 - STANDARD DETAIL SHEETS

For all construction plans submitted to the Harris County Engineering Department pursuant to these regulations, the following requirements shall apply:

1. The Harris County standard paving and detail sheets shall be incorporated by reference in the project specifications and by construction notes on the plans.
2. The details of special structures not covered by approved standard drawings, such as stream and gully crossings, special manholes, etc., should be included. The details shall be drawn on the detail sheets with the horizontal and vertical scales equal.
3. The Harris County Engineering “Express Review Sheet” shall be submitted with each set of plans and be completed including Harris County Appraisal District account number.

SECTION 5.05 - STANDARD NOTE REQUIREMENTS

The following standard notes shall be included in the plans, where applicable, as specified below:

1. All projects shall include the notes in Appendix “D” to these regulations.
2. All projects involving paving or utilities located in a public right-of-way

shall include notes in Appendix “E” to these regulations.

3. All projects involving esplanade openings and turn lanes shall include the notes in Appendix “F” to these regulations.
4. All projects located within the 10% (10-year) floodplain, the 1% (100-year) floodplain, or the 0.2% (500-year) floodplain shall include notes in Appendix “G” to these regulations.

SECTION 5.06 – SUPPLEMENTAL REQUIREMENTS

Unless otherwise directed by the County Engineer, the following additional requirements shall be included with the initial submittal of preliminary plans or prior to final plan approval as set forth below:

1. Harris County Flood Control District approval is required prior to final plan approval.
2. Harris County Toll Road Authority approval is required prior to final plan approval if project encroaches or impact HCTRA right-of-way.
3. Texas Department of Transportation (TxDOT) approval is required prior to final plan approval if project encroaches or impacts HCTRA right-of-way.
4. If required, Traffic Impact Analysis approval is required prior to final plan approval.
5. If project encroaches into a pipeline easement, approval from the owner of the easement is required prior to final plan approval.
6. If utility connections are proposed, approval from the utility owner verifying capacity is required prior to final plan approval.
7. If project encroaches into jurisdictional wetlands, approval from the U.S. Army Corps of Engineers if required prior to final plan approval.
8. Maintenance Agreements for non-standard items located in Harris County right-of-way are required prior to final plan approval.

9. Harris County Capital Improvement Projects Division Interpose “No Objection” letter for projects adjacent or affecting capital projects are required prior to final plan approval.

SECTION 6 - DRAINAGE REQUIREMENTS

SECTION 6.01 - DRAINAGE POLICY

1. Design Requirements

- A. The drainage criteria administered by Harris County and complemented by the City of Houston and the Harris County Flood Control District Criteria for newly designed areas provides street drainage design at a 2-year event frequency, and protects from structural flooding at the 100-year design frequency. Additionally, in areas in or adjacent to mapped floodplains, structural protection is provided for the 500-year design event, using those elevations derived from the effective Flood Insurance Study (FIS). This is accomplished with the application of various drainage enhancements such as storm sewers, roadside ditches, open channels, detention and overland (sheet) run-off.
- B. Recognizing that each site has unique characteristics that may enhance the opportunity to provide proper drainage, the intent of these criteria is to specify *minimum* requirements. These minimums may be modified with prior consent of the Harris County Engineering Department provided that the objective for the minimum drainage standards is maintained.

2. Street Drainage Design - Street ponding of short duration is anticipated and designed to contribute to the overall drainage capability of the system. Storm sewers and roadside ditch conduits are designed as a balance of capacity and economics. These conduits are designed to convey less intense, more frequent rainfalls while attempting to allow traffic movement during these events. When rainfall events exceed the capacity of the storm sewer system, the additional run-off is intended to be stored or conveyed overland in a manner that reduces the threat of flooding to structures.

3. Flood Control Design - Harris County is a participant in the National Flood Insurance Program. The flood insurance program attempts to make flood insurance available at low cost by providing for measures that reduce the likelihood of structural flooding.

4. Relationship to the Platting Process - The approval of storm drainage systems, detention facilities, and flood channel improvements is a part of the review process for planning and platting of new development.

SECTION 6.02 - DESIGN REQUIREMENTS

All designs of major thoroughfare drainage facilities, manholes, inlets, bedding and backfill shall meet the requirements of Standard Specifications, Standard Drawings and Harris County Regulations.

The Standard Specifications, Standard Drawings, Harris County Regulations, as well as the most recently adopted City of Houston design guidelines, will apply for all non-major thoroughfare projects located within Harris County and the City of Houston ETJ. The most stringent design details shall apply in the event of any discrepancy.

Note: With prior approval, products listed in the Harris County Special Specifications 8013 may be used. Alternative types of pipe proposed for use in storm sewer applications must receive prior approval of the County Engineer.

1. Method of Determining Runoff

- A. Area runoff shall be determined using the Rational Formula which is defined as:

$$Q = CiA$$

Where Q = amount of runoff in cubic feet per second (cfs)

C = watershed imperviousness coefficient. See Figure 1: Minimum "C" Values for Land Use Types for suggested typical values.

i = rainfall intensity in inches per hour

Implicit in the determination of "i" is when the entire watershed under consideration is contributing runoff, a concept known as the Time-of Concentration (T_c) ratio, which are expressed in minutes.

T_c represents the time in minutes required for the runoff to flow through the drainage area to the point of consideration. This is defined as:

$$T_c = 10 A^{0.1761} + 15 \text{ (in minutes)}$$

A = acres of subarea under consideration in the watershed area

Note: See Appendix “H” for intensity duration

- B. Design Storm Events for typical storm sewer design will consist of a 2-year storm. Unless otherwise directed by the County Engineer, design rainfall pattern shall follow the requirements specified in the most recently amended HCFCD Criteria Manual. Rainfall intensity for storm sewer design must be determined using Region 3 data (Appendix H) for all regions of unincorporated Harris County.

Figure 1: Minimum “C” Values for Land Use Types	
Land Use Type	Runoff Coefficient
Residential Districts	
Lots more than ¾ acres	0.35
Lots ¼ - ¾ acre	0.45
Lot less than ¼ acre	0.55
Multi-Family Areas	
Less than 20 DU/AC	0.65
20 DU/AC or Greater	0.80
Business Districts	0.80
Industrial Districts	
Light Areas	0.65
Heavy Areas	0.75
Railroad Yard Areas	0.30
Parks / Open Acres	0.18

- C. Application of Runoff Calculation Models
- (1). The Rational Method shall be used for designs on all areas served by storm sewer up to 600 acres in size.
 - (2). Rainfall runoff modeling shall be applied to areas greater than 600 acres in size or any areas that are drained by an open channel provided the model takes into account the

storage and ponding in streets. Models must be acceptable to FEMA if they are to support a submittal for a map change.

D. Coefficients for the Rational Method.

- (1). The runoff coefficient “C” values in the Rational Method formula will vary based on the land use. Minimum to be used is shown in Figure 1: Minimum “C” Values for Land Use Types.
- (2). Alternatively, when the area is not outlined in Figure 1, the runoff coefficient “C” in the Rational Method formula can be calculated from the equation:

$$C = 0.6Ia + 0.2$$

Where C = Watershed coefficient

Ia = percent impervious area (expressed as a decimal)

- (3). If the alternate form is to be submitted, a calculation of the computation of C is to be provided as part of the drainage calculations.

2. Design of Storm Sewers

1. Storm sewers shall be designed using the Manning Equation in combination with the Continuity Equation. Proper consideration will be given to the units of measure, whether English or metric.
2. The Manning Equation is defined as:

$$V = (K/n)R^{2/3} S_f^{1/2}$$

Where K = 1.49 for English units

n = 0.013 for concrete pipes and
0.024 for CMP pipes

V = velocity in feet per second

R = hydraulic radius of the conduit in feet
which equals area/wetted perimeter

S_f = friction slope as headloss per length

3. The Continuity Equation is defined as:

$$Q = VA$$

Where Q = Discharge or runoff in cubic feet per second (cfs)

V = velocity in feet per second

A = Cross-sectional area of conduit in square feet

4. Design Frequency

(1). Newly Developed Areas - The design storm event for sizing storm sewers in newly developing areas shall be a two (2) year rainfall.

(2). Redevelopment or In-Fill Development with Increased Rate of Runoff - The existing storm drain serving redevelopment or infill development shall be evaluated in accordance with conditions outlined below, using a 2-year rainfall, assuming existing development conditions. Afterwards the storm drain shall be re-evaluated with the proposed re-development, or in-fill development, in place.

(a). If the hydraulic gradient is twelve inches (12”) or less above the top of curb with the flow in the receiving channel at the top of the outfall pipe and no structures are threatened by the project, then no improvements to the existing storm drain are required.

(b). If the extreme event analysis indicates that structures are threatened by flooding, the applicant has the option of either making improvements to the existing storm drain or providing detention or improving the receiving stream and not impacting downstream conditions.

5. Velocity Considerations

(1). Storm sewers should be constructed to convey the design flow in sub critical hydraulic conditions if possible.

- (2). Minimum 2-year flow velocities should not be less than three feet (3') per second with the pipe flowing full, under the design conditions.
- (3). Maximum 2-year flow velocities should not exceed eight feet (8') per second.

6. Pipe Sizes and Placement

- (1). Soil boring with logs shall be made along the alignment of all storm sewers having a cross section equal to or greater than seventy-two inches (72") in diameter or equivalent cross sectional area. Each boring shall be taken at intervals not to exceed five hundred (500) linear feet and at a depth of less than three feet (3') below the flow line of the sewer. The required bedding will be determined from the soil boring.
- (2). The storm sewer and inlet lead shall be designed with a minimum of twenty-four inch (24") inside diameter or equivalent cross sectional area. Box conduits shall be a minimum of two feet (2') by two feet (2'). Closed conduits, either circular, elliptical, or box, shall be selected based on hydraulic principles and economy of size and shape.
- (3). Larger pipes upstream should not flow into smaller pipes downstream unless construction constraints prohibit the use of a larger pipe downstream, or the improvements are outfalling into an existing system, or the upstream system is intended for use in detention.
- (4). Match crowns of trunk storm sewer pipe at any change in pipe size unless severe depth constraints prohibit the matching of crowns. Severe depth constraints include any system in which the outfall system exists and the designed storm system cannot achieve 2 feet or more of cover at the point of lowest cover without additional fill. This includes:
 - (a). Any system that includes a lake or detention pond, and the depth of the storm sewers is constrained by that lake or detention pond, and the designed storm sewer system cannot achieve 2 feet or more cover at the point of lowest cover without additional fill.

- (b). Any time there is a conflict with the existing utility system which cannot be reasonably relocated. This includes large diameter water lines, underground electrical conduits, underground telecommunication conduits, petrochemical pipelines, or sanitary sewers.
- (c). Any time there is a conflict with a proposed sanitary sewer system which cannot be avoided due to design criteria constraints. This includes but may not be limited to sanitary sewers and their service leads.
- (d). The saving of specimen trees which would be harmed by fill on lots with a minimum lot size of 8400 sf. A tree survey must be provided showing location, size and species of trees proposed to be saved.
- (5). Locate storm sewers in public street rights-of-way or in approved easements. Proposed storm sewers shall not be laid parallel to and under proposed or existing pavement. Parallel storm sewer must be laid at least two feet (2') from the back of curb or edge of pavement to the outside edge of the pipe. Perpendicular roadway crossings are acceptable.
- (6). All precast, reinforced, concrete conduits must be laid in a straight line. Deflection in accordance with manufacturer's specifications will be allowed if on approved plans.
- (7). All public side lot or back lot drainage facilities shall be underground storm sewer systems designed in accordance with these Harris County standards. Drainage swales are permitted for off-site sheet flow only. Private, individual lot drainage is exempt from this requirement except when discharging into a public right-of-way.
- (8). In all easements restricted to storm sewers, the conduit shall be centered within the limits of the easement. The width of the easement shall be two (2) times the depth plus the diameter of the pipe rounded up to the next highest five foot (5') increment. The minimum shall never be less than twenty feet (20').

- (9). For storm sewers located in easements adjacent to public street rights-of-way, the minimum width shall be increased for larger pipe or conduit by requiring that a minimum distance of five feet (5') shall be maintained between the easement line and the outside edge of the sewer, and a minimum distance of two feet (2') shall be maintained from the right-of-way line to the outside edge of the sewer pipe or conduit.
- (10). Do not place the bell of the RCP within an inlet, junction box, or manhole structure. The bell must be cleanly sawed and removed prior to placement.

7. Starting Water Surface and Hydraulic Gradient

- (1). The hydraulic gradient shall be calculated using the top of the outfall pipe as the starting water surface elevation.
- (2). Should the upstream pipe be higher than the hydraulic grade line at drop in pipes invert, then the hydraulic grade line shall be recalculated assuming the starting water surface to be at the top of the pipe at that point.
- (3). For the design storm (a two year frequency), the hydraulic gradient shall at all times be below the gutter line.

8. Manholes

- (1). Use manholes for precast conduits at the following locations:
 - (a). Size or cross section changes.
 - (b). Inlet lead and conduit intersections.
 - (c). Changes in pipe grade.
 - (d). At a maximum space of seven hundred feet (700') along a conduit run.
- (2). Use manholes for monolithic concrete storm sewers at the same locations as precast conduits, except they are not required at the intersection of inlet leads unless needed to provide maintenance access.

- (3). All manholes constructed on proposed or existing major thoroughfares shall be constructed in accordance with Harris County Specifications.
- (4). All precast manholes must conform to ASTM C 913. Cored or blocked out pipe openings must be designed to closely fit the outside diameter of the proposed tie in. Precast manholes with thin-wall knockouts to accommodate a range of pipe sizes will not be allowed in the right-of-way.
- (5) Incoming and outgoing reinforced concrete pipe must be at least three inches (3") away from the corner of the junction box structure as measured from the outside edge of the pipe to the inside corner of the structure. If the junction box structure is pre-cast to accept the corner tie in or the structure was otherwise designed to accept this, the design engineer shall submit the design plans and specifications to Harris County prior to street acceptance.

9. Inlets

- (1). Locate inlets at all low points in gutter or at intermediate points in the profile grade to provide proper drainage.
- (2). Inlets should not be placed within driveway locations/limits but should be placed in the center of the lot.
- (3). Valley gutters across intersections are not permitted.
- (4). Inlet spacing is a function of gutter slope and should be designed to conform with the Pavement Design Requirements and Drainage Design Requirements of these design guidelines.
 - (a). Local and collector street section: For minimum gutter slopes, the maximum inlet spacing shall be a gutter run of seven hundred feet (700') at high point in pavement or the adjacent inlet, with a maximum of one thousand four hundred feet (1400') of pavement draining towards any one inlet location.
 - (b). On cul-de-sac or partial cul-de-sac sections, gutter runs shall be limited to four hundred feet (400').

- (c). On major thoroughfares, gutter runs shall be limited to three hundred feet (300').
- (5). Use only Harris County and City of Houston Standard Inlets shown in Figure 3, "City of Houston Standard Inlets Acceptable to Harris County."
 - (6). Storm sewer leads must be tied directly into the face or back of "B-B" or "H-2" inlet box and shall not be tied into the short side of "B-B" or "H-2" inlets.
 - (7). Do **not** use "**Beehive**" grate inlets or other "specialty" inlets.
 - (8). Do **not** use unprotected grate-top inlets in unlined roadside ditch.
 - (9). Do **not** place inlets in circular portion of cul-de-sac streets unless special conditions warrant otherwise and are included on approved plans and are approved prior to placement.
 - (10). If drainage will enter or leave proposed pavement then inlets must be located at the end of proposed pavement.
 - (11). Do **not** locate inlets adjacent to median openings.
 - (12). Place inlets on side streets intersecting major streets, unless special conditions warrant otherwise and are included on approved plans.
 - (13). All precast inlet boxes must conform to ASTM C 913. Cored or blocked out pipe openings must be designed to closely fit the outside diameter of the proposed tie in. Precast inlets or catch basins with thin-wall knockouts to accommodate a range of pipe sizes will not be allowed in the right-of-way.
 - (14). Incoming and outgoing reinforced concrete pipe must be at least three inches (3") away from the corner of the inlet structure as measured from the outside edge of the pipe to the inside corner of the structure. If the inlet structure is pre-cast to accept the corner tie in or the structure was otherwise designed to accept this, the design engineer shall

submit the design plans and specifications to Harris County prior to street acceptance.

- (15). Type “E” inlets shall not be used in the right-of-way, with exception for temporary locations for interim drainage in areas of future half boulevard. Use of Type “E” inlets in this application shall be confirmed by the County Engineer.

FIGURE 2: City of Houston Standard Inlets Acceptable to Harris County			
Inlet Type	Application	Capacity	City of Houston Drawing Number
A	Parking Lots / Small Areas	2.5 cfs	02632-01
B-B	Residential / Commercial	5.0 cfs	02632-04
C	Residential / Commercial	5.0 cfs	02632-06
C-1	Commercial	10.0 cfs	02632-06
C-2	Commercial	15.0 cfs	02632-06
C-2A	Commercial	20.0 cfs	02632-06
D	Parking Lots	2.0 cfs	02632-07
D-1	Small Areas	2.5 cfs	02632-08
E	Temporary Drainage Swales	20.0 cfs	02632-09 & 02632-10
H-2	Residential / Commercial	5.0 cfs	02633-01 & 02633-02

3. Consideration of Overland Flow

- A. Extreme Event Analysis – The design frequency for consideration of overland sheet flow will consider extreme storm events. These events, which exceed the capacity of the underground storm sewer system and result in ponding and overland sheet flow, shall be

routed to drain along street rights-of-way or open areas and through the development to a primary outlet.

B. Relationship of Structures to Street

- (1). All structures shall be higher than the ponding anticipated in areas immediately adjacent to the structure as anticipated by the extreme event analysis.
- (2). The engineer shall show the proposed structure's minimum slab elevation at eighteen inches (18") above the 1% 100-year floodplain, one-foot (1') above the ponding depth within a ten foot (10') radius of the proposed buildable area, or at or above the 500-year floodplain elevation as determined by the Floodplain Insurance Study, whichever is applicable and greater.
- (3). Slab and drainage elevations, conduit locations, and grading for the extreme event shall be shown on a specifically designated page of construction plans.
- (4). An engineer's certification stating that the grading, elevations, and drainage are within engineering tolerances of the approved subdivision plan set without publicly dedicated streets shall be submitted prior to issuance of single family residential structure permits associated with that approved plan set.

C. Calculation of Flow

- (1). Streets will be designed so that consecutive high points in the street will provide for a gravity flow of drainage to the ultimate outlet.
- (2). The maximum depth of ponding at high points will be six inches (6") above top of curb during an extreme event condition.
- (3). The maximum depth of ponding at low points will be eighteen inches (18") above the top of curb during an extreme event condition.

- (4). Along major thoroughfares and principal arterial streets, the depth of water along the median gutter section shall not exceed three inches (3”) in depth under the extreme event condition.
 - (5). Sheet flow between lots may be provided only in connection with a defined drainage easement.
 - (6). A map shall be provided which delineates extreme event flow direction for both offsite, and through a proposed development. The map shall also show the method of discharge to the primary drainage outlet. Positive drainage must be provided to intercept offsite sheet flow.
 - (7). In areas where ponding occurs and where no sheet flow path exists, a calculation must be provided which demonstrates how the runoff from a 100-year event will be conveyed and remain in compliance with the other terms of this Section.
- D. Interim off-site sheet flow: Drainage swales may be used for interim offsite sheet flow in lieu of closed conduits in phased projects and for projects adjacent to existing development. This is required any time the proposed development will cause ponding on an adjacent owner’s property.

In areas where the project design incorporates fill adjacent to the adjacent property, the Contractor shall implement grading and/or perimeter runoff catchment devices (e.g.- perimeter ditches) during construction to ensure that adjacent parcels bordering the project site do not experience increased interim drainage flows or carry sediment generated as part of construction activities. The interim drainage allowed to leave the property shall not exceed the pre-developed conditions. Where applicable, these practices are in addition to the standard Storm Water Pollution Prevention design and shall include additional ditches redirecting site drainage or temporary piping. This note is not intended to replace or address any liability or responsibility under Texas Water Code 11.086.

4. Design of Open Channels

A. Design Frequency

- (1). Unless otherwise directed by the County Engineer, open channel design and construction standards shall follow the requirements specified in the most recently amended HCFCD Criteria Manual.
- (2). Unless otherwise directed by the County Engineer, design standards for outfalls into channels shall conform to those standards delineated in the most recently amended HCFCD Criteria Manual.

B. Determination of Water Surface Elevation

- (1). Water surface elevations shall be calculated using Manning's Equation and the Continuity Equation.
- (2). For the design storm event, the water surface must be calculated to remain within banks.

C. Design of Culverts

- (1). Head losses in culverts shall conform to Texas Department of Transportation Hydraulic Manual, Chapter 4 – Culverts.
- (2). Corrugated metal pipe will *not* be approved for permanent culverts in Harris County rights-of-way except at railroad crossings, and if used underneath the railroad crossing, the culvert shall be designed to railroad loadings.

D. Design of Outfalls

- (1). Unless otherwise directed by the County Engineer, all outfall designs shall conform to the HCFCD Criteria Manual.

5. Design of Roadside Ditches

A. Design Frequency

- (1). Roadside ditch design is permissible only for commercial areas equal to or less than one (1) acre or for single-family residential lots. Detention is required in accordance with Section 6.03 for all other conditions.

- (2). The design storm event for the roadside ditches shall be a two (2) year rainfall.
- (3). Design capacity under the two (2) year storm event for a roadside ditch shall be no less than 0.5 feet below the edge of pavement or the natural ground at the right-of-way line, whichever is lower.
- (4). The design shall include an extreme event analysis to indicate that the proposed structures will not be flooded.
- (5). Outfall drainage to existing roadside ditches shall be limited to tracts with frontage along the roadside ditch. If no frontage to the roadside ditch exists, but it can be shown with detail topographic surveys that the tract ultimately drains to the roadside ditch, then outfall will only be considered with full retention of the storm water during the design rainfall event.

B. Velocity Considerations

- (1). For grass-lined sections, the maximum design velocity shall be four feet (4') per second during the design event.
- (2). A grass-lined or unimproved roadside ditch shall have side slopes no steeper than three (3) horizontal to one (1) vertical (3:1) or as soil conditions will permit. Steeper slopes will be allowed when the existing right-of-way is limited or other construction features dictate the design. The steepest slope shall not exceed two (2) horizontal to one (1) vertical (2:1).
- (3). The minimum grade for roadside ditches shall be 0.1 foot per 100 feet.
- (4). Calculation of velocity shall use a Manning's roughness coefficient of 0.04 for earthen sections and 0.025 for ditches for paved inverts.
- (5). Erosion control methods shall be used when design velocities are expected to be greater than four feet (4') per second or where erodible soil conditions are indicated in the geotechnical report.

C. Culverts

- (1). Culvert length shall be determined by measuring the width of the crossing and adding a one-foot (1') shoulder to each edge of radius of the crossing and the intersection length from the edge of the shoulder to the flow line of the ditch. The slope will not be steeper than a three (3) horizontal to one (1) vertical (3:1) at each end.
- (2). Culverts shall be placed at all driveway and roadway crossings and other locations where deemed necessary. The size and grade of the culvert(s) shall be provided for each lot.
- (3). Pipe culverts shall conform to ASTM C-76, Class III, for reinforced concrete pipe.
- (4). The size of roadside culverts is to be based upon drainage area. Notwithstanding this requirement, the minimum culvert size shall be eighteen inches (18") for residential and commercial driveways.
- (5). All proposed and reasonably expected future culverts shall be included in the hydraulic profile. The culvert used shall not create a headloss of more than 0.20 feet greater than the normal water surface profile without the culvert.
- (6). Storm water discharging from a ditch into a storm sewer system must be intercepted by use of an appropriate structure (i.e., stubs with ring grates or type "E" manholes).

D. Invert Protection

- (1). Ditch invert protection shall be used when velocities exceed four feet (4') per second.
- (2). Ditch invert protection will be used at the upstream and downstream ends of all culverts.

E. Depth and Size Limitations for Roadside Ditches

- (1). The maximum depth for a roadside ditch shall not exceed four feet (4') below the adjacent road centerline top of

pavement. There may be instances where extreme conditions may warrant a deeper ditch. In those cases, specific written prior approval must be obtained from the Harris County Engineering Department.

- (2). Roadside ditch bottoms shall be at least two feet (2') wide, unless design analysis supports a narrower width and prior written approval is obtained from the Harris County Engineering Department.
- (3). A minimum distance of two feet (2') shall be established and maintained between the right-of-way line and the adjacent edge of the bank of a ditch.

SECTION 6.03 - STORM WATER DETENTION

1. Application of Detention

A. If new development or redevelopment has the opportunity to drain directly into a channel maintained by HCFCD, then HCFCD criteria shall prevail unless otherwise directed by the County Engineer.

(1). If the drainage system for a development project outfalls directly into a channel maintained by the HCFCD, and the requirements of the HCFCD include payment of an impact fee, then no further impact fees or detention will be required by Harris County Engineering Department.

(2). If redevelopment occurs without increasing the overall impervious character of the site, or without increasing the drainage outfall capacity from the site, then no detention will be required.

(3). If the development involves only one single family residence where no major changes in existing drainage are proposed and the tract is not part of a larger development project, then no detention will be required.

(4). If development involves only lots fronting on County roads, no detention is required if the developed area is contained within the 150 foot lot depth fronting the road or the total impervious area does not exceed the area calculated by multiplying the 150 foot lot depth by the lot width adjacent to the County road. This provision is only applicable for single-family residential lots where no changes in existing drainage patterns are proposed for the remainder of the lot.

B. Use of on-site detention to mitigate impacts on Harris County maintained drainage systems is required under these regulations when either:

(1) It is proposed that commercial development outfall into a Harris County roadside ditch; or

(2) It is proposed that the tract or development outfall to a Harris County storm sewer system and the capacity allocated to the tract in the original design calculations is less than

projected for the proposed development. This shall be evaluated using either the methodology documented in the original design calculations or that outlined in these regulations.

- C. Separate from the requirements of 6.03.1.B. above, use of on-site detention to mitigate impacts on defined channels at or downstream of the site may be required under Harris County's Floodplain Regulations. Unless otherwise directed by the County Engineer, Harris County will rely on the technical review in accordance with the most recently amended HCFCD Policy Criteria and Procedures Manual in determining detention requirements under the most recently amended Harris County Floodplain Regulations.
- D. Where on-site detention is required under both criteria (B and C), the largest detention storage rate determined under each criteria shall apply.

2. Calculations of Detention Volume

- A. Unless otherwise directed by the County Engineer, design rainfall shall follow the requirement specified in the most recently amended HCFCD Criteria Manual.
- B. Detention volume for new development areas is to be calculated based on the gross area of the tract being developed. However, the County Engineer may grant phased detention for phased commercial projects based on the portion of the tract being developed at the time. All future development will require approval from the County Engineer.
- C. Detention volume for redevelopment areas is to be calculated on the basis of the amount of area of increased impervious cover.
- D. Detention volume for areas proposed for gravity outfall shall be:
 - (1). Roadside ditch outfall - Unless otherwise directed by the County Engineer, minimum storage rate of 1.0 acre feet per acre unless a Method 2 hydrologic and hydraulic analysis, as defined by the most recently amended Harris County Flood Control District Design Criteria Manual, shows a lower rate and volume is acceptable. The discharge rate shall be limited to the capacity of as outlined in Section 6.03 (4)(A).

NOTE: If a method 2 analysis is performed, the minimum detention volume shall not be less than 0.75 acre-feet per acre.

- (2). Storm sewer outfall - Unless otherwise directed by the County Engineer, minimum storage rate of 0.75 acre-feet per acre unless a formal Method 2 hydrologic and hydraulic analysis, as defined by the most recently amended Harris County Flood Control District Design Criteria Manual, shows a lower rate and volume is acceptable. The discharge rate shall be limited to the existing storm sewer capacity allocated to the tract.

E. For the areas proposed for pumped/gravity combination outfall, the following criteria shall apply:

- (1). The detention volume shall be the same as D(1) and D(2), **EXCEPT THAT** the volume of pumped flow shall be limited to 50% of total basin capacity.

NOTE: The minimum detention volume shall not be less than 1.0 acre-feet per acre for a pumped/gravity combination system that outfalls into a roadside ditch and 0.75 acre-feet per acre for a pumped/gravity combination system that outfalls into a storm sewer.

- (2). Automatic controls shall be incorporated to shut off all pumping when outfall system capacity is reached. Additionally, a gravity return line to the detention facility must be provided for additional head control in the event of failure of automatic level controls. Pumping cannot be resumed until the outfall has receded to one-half ($\frac{1}{2}$) the depth of the roadside ditch.
- (3). Drain Time - Maximum drain time is four (4) days. If drain time is longer than four days, use the increase in detention volume that approximates the drain time as shown in Figure 3. If the maximum discharge rate from the detention facility to a roadside ditch is insufficient to allow the facility to drain within seven days, this is likely an indication that the proposed area to be developed is too large to be accommodated within the existing roadside ditch. In this case, an alternative drainage solution may be required which

could include acquisition of off-site drainage easements and construction of open channel ditches to serve the development. If the calculated drain time exceeds seven days, consult with the County Engineer.

FIGURE 3: Increase in Detention Volume	
Duration	Increase in Detention Volume
4 Days	0%
5 Days	5%
6 Days	15%
7 Days	25%

- F. When parking areas are used for detention, the maximum depth of ponding in parking areas shall be nine inches (9”) directly over the inlet grate.
- G. Outfall drainage to existing roadside ditches shall be limited to those tracts with frontage along the roadside ditch. In cases where no frontage on roadside ditch exists, but where it can be shown with detail topographic surveys that the tract ultimately drains to the roadside ditch, the minimum detention volume shall not be less than 1.0 acre-feet per acre. The allowable discharge rate to a roadside ditch shall be limited to the pro-rata share of the existing capacity of the roadside ditch at the point of outfall or any location downstream, whichever is less as outlined in Section 6.03 (4)(A).

3. Design of Basin

The following requirements shall apply for basins designed under these Regulations:

- A. The side slope ratio shall be 3:1 or flatter depending on local soil conditions.

- B. The design must either prevent sheet flow down the basin side slopes or provide for adequate erosion control through the back slope drains, concrete slopes, or other acceptable methods.
- C. Dry bottom basins shall be sloped to drain and dry out between storm events in order to accommodate maintenance. The minimum bottom traverse slope shall be three-fourths of one percent (0.75%), and the minimum pilot channel slope shall be one-tenth of one percent (0.1%).
- D. Wet bottom basins shall meet the following criteria:
 - (1). A minimum of six feet (6') of permanent water depth is required unless the wet bottom is for purposes of wetlands.
 - (2). A six-foot (6') width minimum shelf, one-foot (1') above static water's surface elevation is required.
 - (3). Side slopes must meet the following criteria:
 - (a). A ratio of 3:1 from shelf to bottom of basin; or
 - (b). A ratio of 3:1 or flatter depending on local soil conditions from above shelf to natural ground.
 - (4). Alternatives to items D(2) and D(3) above may be approved provided the facility design demonstrates that it can be easily maintained with due consideration of public safety.

4. Detention Outfall Facilities

- A. The maximum discharge rate for detention facilities shall be limited to the capacity allowed to the subject tract of the receiving storm sewer. In the case of a roadside ditch outfall, the rate of runoff from the front one hundred-fifty feet (150') of the tract calculated is defined in Section 6.02 (1) of these regulations, assuming a runoff coefficient "C" of 0.2. Alternatively, the allowable discharge rate to a roadside ditch can be calculated based upon the pro-rata share of the existing capacity of the roadside ditch at the point of outfall or any location downstream, whichever is less. Capacity of the roadside ditch shall be computed using detailed topographic survey of the ditch and Manning's Equation as outlined in Section 6.02 (2) (B). Pro-rata share of capacity shall be

computed as the ratio of the detention pond service area (including the detention pond) that naturally drains to the roadside ditch divided by the total drainage area of the roadside ditch upstream of the outfall location.

B. The outfall orifice shall be designed using the following equation:

$$Q = CA \sqrt{2gh}$$

$$D = Q^{1/2} / 2.25 h^{1/4}$$

Where Q = outflow discharge in cubic feet per second (cfs)

$$C = 0.8$$

$$A = \text{orifice area}$$

$$h = \text{head - water surface differential - typically two feet (2'), but no less than 0.5 feet}$$

$$g = \text{gravity - 32.2 feet / sec}^2$$

$$D = \text{diameter of orifice (inches)}$$

C. Restrictor Criteria

- (1). An appropriate sized restrictor system must be installed to ensure detention volume is utilized. If circular pipe of less than six inches (6") is to be used, appropriate measures must be incorporated to ensure clogging of the outfall pipe does not occur.
- (2). The outfall pipe containing the restrictor shall be a minimum of eighteen inches (18") or six inches (6") greater than the restrictor pipe size, whichever is larger.
- (3). The restrictor shall be located in the upstream end of the outfall pipe.

D. Outfall Method

- (1). The outfall pipe shall be ASTM C76, Class III Reinforced Concrete.
- (2). The restrictor shall be PVC or other material acceptable to the Harris County Engineering Department.
- (3). All gravity discharges shall be designed to prevent erosion of the roadside ditch.
- (4). Pump systems:
 - (a). An outfall from a pumped discharged system shall not discharge directly into the roadside ditch but shall provide a stilling manhole or basin for pump system energy dissipation prior to a gravity discharge.
 - (b). The entrance velocity into the roadside ditch shall ***not*** exceed three feet (3') per second.
 - (c). A maximum level control and return line to the detention basin shall be provided to limit head build up and control outflow into the roadside ditch during a flooding event.

- E. A gravity spillway must be provided in addition to the pipe outlet to protect structures from flooding in the event the capacity of the basin is exceeded.

SECTION 6.04 - OWNERSHIP AND EASEMENTS

1. Private Facilities

- A. Submission of pump system specifications and a written operating plan that defines how the pump(s) will be controlled to avoid overloading the existing system is required when pump discharge outfalls into a roadside ditch. This information shall be included in the plan detail sheets.

- B. A maintenance work area of twenty feet (20') in width surrounding the extent of the detention area shall be provided. Permanent access easements and necessary utility easements and parking lots may be included as a portion of this twenty-foot (20') width as determined by the County Engineer.
- C. Notice of Detention Requirements Form
 - (1). Blank forms are available upon request.
 - (2). The "Notice of Detention Requirements" forms shall indicate the party responsible for maintenance of the detention facility.
 - (3). A signed and notarized "Notice of Detention Requirements" shall be filed in the Harris County Clerk's Office, Real Property Records.
 - (4). Once filed, the form becomes a legal document attached to the property in perpetuity.
 - (5). If conditions change and the detention system is no longer required, the Harris County Engineering Department will notify, in writing, the Harris County Clerk's Office, Real Property Records. Such notice shall unencumber the property from the previously recorded "*Notice of Detention Requirements*" form.
- D. Any facility serving a single-family residential subdivision with 14 or more lots and private streets, shall have the detention facility maintained by a political subdivision of the state.

2. Public Facilities.

- A. Detention facilities will be accepted for maintenance by the Harris County Flood Control District in cases where public drainage is being provided and the facilities meet minimum requirements for acceptance.

- B. A maintenance work area of thirty feet (30') in width surrounding the detention area must be provided. Up to 10 feet of public right-of-way may be included as a portion of the 30-foot width.
- C. A dedication of easement shall be provided by plat or by separate instrument.
- D. For wet bottom basins, the minimum wet surface area shall be one (1) acre unless it incorporates storm water quality features such as wetland areas.
- E. Any facility draining water from public streets shall be maintained by a governmental body such as a municipal utility district or HCFCD.

SECTION 6.05 – SUBMERGED STORM SEWERS

The use of submerged storm sewers should be avoided unless it is part of a storm water quality feature/amenity lake system. For the purpose of these regulations, storm sewer systems are not considered submerged where only the outlet pipe from the last manhole entering a storm water quality/amenity lake system is below static water surface. In this case, storm sewers shall meet the following conditions:

Permanent Access Easements/Private Streets/Storm Sewers

1. Incorporate methods to drain the system in case of repairs. Methods include specifying locations of cofferdams, specifying portable pump equipment, and providing a sequence that would result in being able to drain any portion of the storm sewer within 3 days with the longest allowable time being 5 days.
2. In order to reduce the possibility of mosquito breeding, a system shall be designed such that sections of storm sewer are dry or hold a minimum of 3 inches of water and are continuously connected to the lake feature.

Public Streets/Storm Sewers

1. Incorporate a sluice gate system into design so that the lake can be drained by gravity. If desired, an additional sluice gate may be added to isolate the storm sewer system from the lake.
2. Design the sluice gate system such that upon opening, the lowest portion of the storm sewer will drain dry by gravity within 3 days with the longest allowable time being 5 days.
3. If equipped with a sluice gate designed to isolate the storm sewer, the manhole adjacent and upstream of the sluice gate must have a sump of sufficient depth to allow for pumping the system dry.
4. Provide an Interlocal Agreement, in a form acceptable to the County Attorney, between the utility district or other political subdivision of the State and the County indicating the following:
 - a) The entire system shall be covered by a drainage easement dedicated to the public.
 - b) The utility district will accept the dedication of the sluice gate system for maintenance.
 - c) The utility district will make available to the County all complaints regarding the storm sewer system and the utility district's repair and maintenance records.
 - d) The utility district agrees not to damage any pavement or storm sewer in its maintenance of the sewer system.
5. In order to reduce the possibility of mosquito breeding, a system shall be designed such that sections of storm sewer are dry or hold a minimum of 3 inches of water and are continuously connected to the lake feature.

The following additional design requirements apply to submerged storm sewer systems.

- a) The hydraulic gradient shall be calculated using the static lake level as the starting water surface elevation.
- b) All storm sewer pipe shall be reinforced concrete pipe ASTM, C-76, Class III with joint conforming to ASTM C443 with rubber gaskets conforming to ASTM, C1619.

- c) All storm sewers shall be encased in cement stabilized sand in conformity with City of Houston drawings, 02317-02, 02317-03, 02317-05, 02317-06, and 02317-07, as appropriate.
- d) Submerged storm sewer systems are not allowed within the rights-of-way of major thoroughfares.

SECTION 6.06 – LOW IMPACT DEVELOPMENT AND GREEN INFRASTRUCTURE

A Low Impact Development (LID) or Green Infrastructure (GI) technique may be utilized to address drainage and storm water quality requirements provided:

1. The proposed LID or GI technique conforms to the Harris County Low Impact Development & Green Infrastructure Design Criteria for Storm Water Management (Design Criteria) as adopted by Commissioners' Court; and
2. Prior to submitting plans for acceptance, the proposed LID or GI technique must be reviewed in a pre-project meeting in accordance with the Design Criteria.

SECTION 7 - PAVING

SECTION 7.01 - PAVING DESIGN REQUIREMENTS

The following design requirements are applicable to all pavement that is designed and constructed under Harris County jurisdiction by the development community.

SECTION 7.02 - DESIGN REQUIREMENTS

The following design requirements are applicable to pavement within the Harris County street right-of-way:

1. **PAVEMENT WIDTH-** The width shall be in accordance with the following Table 7.1, “Roadway Classifications and Section Requirements” and the “Geometric Design Guidelines for Subdivision Streets” as most recently adopted by Harris County Commissioners’ Court.
2. All proposed major thoroughfares within unincorporated Harris County shall meet the current design criteria as promulgated by the County Engineer. The City of Houston Major Thoroughfare Plan, all other municipalities’ Major Thoroughfare Plans, and the Thoroughfare Amendment Study for Unincorporated and Non-ETJ Areas of Harris County, Texas as adopted by Harris County Commissioners Court will be used to determine when a roadway is classified as a major thoroughfare.
3. Major thoroughfare intersections, including intersections between local/collector streets with major thoroughfares, shall not exceed 1% algebraic grade difference. Transitions to achieve that grade must be made in advance of the intersection and beyond the intersection. Proposed top of pavement elevations shall be provided along the gutter lines and pavement centerlines to show conformance with grade requirements. An “As-Built” record drawing shall be provided to Harris County prior to scheduling an inspection.
4. The engineer shall design and prepare plans for the full boulevard within the limits of all proposed major thoroughfares. Developer’s requirements is to only build one half of the boulevard and entire drainage system including any required detention for the full

boulevard unless location specific needs dictate an alternate consideration approved by the County Engineer.

5. Centerline of swales used to drain the unimproved half boulevard section shall be placed to drain to future inlets which must be constructed to stage one with type E inlets.

Table 7.1 Roadway Classifications and Section Requirements

Land Use on Both Sides of Right-of-Way (R.O.W.)	Roadway Classification	Portland Cement Concrete						
		Single Paving Section	Double Paving Section				Major Thoroughfare	
			Width	Curb	Width	Curb	Width	Curb
Single family Residential on both sides of R.O.W.	Local	28' (B-B)	6" or 4" x 12	2/25'	6" or 4" x 12			
Single Family Residential Reserve Restricted to Landscape or pocket parks less than one acre	Local	28' (B-B)	6" or 4" x 12 6"	2/25'	6" or 4" x 12 6"			
Single Family Residential Detention Pond or Amenity Lake	Local	28' (B-B)	6" or 4" x 12 6"	2/25'	6" or 4" x 12 6"			
Single Family Residential Reserve Restricted to Recreation/Open	Collector	41' (B-B)*	6" or 4" x 12 6"	2/25'	6" or 4" x 12 6"			
Single Family Residential Unrestricted or Restricted to Commercial or Industrial	Collector	41' (B-B)	6" or 4" x 12" 6"	2/25'	6" or 4" x 12" 6"	25' (B-B)	6" only	
Restricted Reserve to Commercial or Industrial on both sides of R.O.W.	Collector	41'(B-B)	6"	2/25'	6"	25' (B-B)	6" only	

*A waiver to this requirement may be requested if onsite parking is proposed. A site plan for the reserve development indicating the type of facilities and number of parking spaces proposed is required to be submitted with the preliminary infrastructure plan submittal. Harris County will make a determination if the proposal is satisfactory. If acceptable, a letter of certification from the developer stating that the required number of parking spaces will be provided in connection with the development of the reserve is required as a condition of signature and approval of the infrastructure plans

Notes:

1. 4x12 curb section shall only be approved on streets where single family structures are taking direct primary access.
2. Alternative paving sections may be considered and approved by the County Engineer for master planned, mixed-use developments.

Table 7.1 Continued below:

Land Use on Both Sides of right-of Way (R.O.W.)	Roadway Classification	Single Paving Section with Roadside Ditches	Double Paving Section with Roadside Ditches	Asphaltic Concrete Single Paving Section with Roadside Ditches
		Width	Width	Width
Single family Residential on both sides of R.O.W.	Local	22' (E-E) with 6' shoulders	2/24' (E-E) with 6' shoulders	22' (E-E) with 6' shoulders
Single Family Residential Reserve Restricted to Landscape or pocket parks less than one acre	Local	22' (E-E) with 6' shoulders	2/24' (E-E) with 6' shoulders	22' (E-E) with 6' shoulders
Single Family Residential Detention Pond or Amenity Lake	Local	22' (E-E) with 6' shoulders	2/24' (E-E) with 6' shoulders	22' (E-E) with 6' shoulders
Single Family Residential Reserve Restricted to Recreation/Open	Collector	41' (E-E) with 6' shoulders	2/24' (E-E) with 6' shoulders	41' (E-E) with 6' shoulders
Single Family Residential Unrestricted or Restricted to Commercial or Industrial	Collector	41' (E-E) with 6' shoulders	2/24' (E-E) with 6' shoulders	41' (E-E) with 6' shoulders
Restricted Reserve to Commercial or Industrial on both sides of R.O.W.	Collector	41' (E-E) with 6' shoulders	2/24' (E-E) with 6' shoulders	41' (E-E) with 6' shoulders

PAVEMENT THICKNESS

A. Local, Collector, Major Thoroughfare

- (1). Concrete - The requirements presented in Table 7.2 below shall be the minimum allowable local, collector, thoroughfare thicknesses utilizing Portland cement concrete. These thicknesses were developed considering both the Portland Cement Association (PCA) design method (“Design of Concrete Pavement for City Streets”, 1974) and the American Association of State Highway and Transportation Officials (AASHTO) method (“AASHTO Guide for Design of Pavement Structures”, 1993).

Table 7-2. Concrete Thickness for 30-Year Design Life

Roadway Classification	Concrete Pavement Thickness, in.	28-day Compressive Strength, fc', psi	Minimum Required Depth of Stabilization, in.
Local ²	6	3000	6
Collector ²	7	3000	8
Major Thoroughfare ²	8 ¹	4500	8
	10 ¹	3000	8

Notes:

1. For major thoroughfares in excess of 30,000 VPD (see criteria below).
 2. For paving design purposes, see definitions for local, collector, and major thoroughfare as described in “Section 12 - Traffic” of these regulations.
- (2). Asphalt, Flexible Base - roads shall use a minimum of a six-inch (6”) stabilized subgrade, eight inches (8”) of base course, one and one-half inches (1½) hot mixed, hot laid asphalt. Alternative pavement design may be considered provided the equivalent structural number is met or exceeded. Flexible base pavement for all developments,

other than low density, single-family, shall be designed in accordance with the design parameters in Section 2, below.

- B. Major Thoroughfares with an excess of 30,000 VPD on year 15 of design life, a licensed engineer shall design the pavement thickness and reinforcement using the AASHTO method and Harris County Engineering Department specified design parameters. The pavement thickness and reinforcement design shall be based on a current soil analysis, stabilized subgrade, roadway use (including the design lane traffic volume) and life span of the proposed pavement.

Harris County Engineering Department specified design parameters for reinforced concrete designs for Major Thoroughfares are:

<u>AASHTO Design Parameter</u>	<u>Design Value</u>	<u>Comments</u>
Drainage Coefficient, C_d	1.2	Good to excellent, 1% Excellent, 1% to 5%
Load Transfer Coefficient, J	3.2	Jointed, reinforced pavement with load transfer such as dowels, specified by detail
Loss of Support, LS	1	
Modulus of Rupture, S'_c	See comment	Dependent on required concrete compressive strength $M_r=570$ psi for $f'_c = 3000$ psi $M_r=620$ psi for $f'_c = 3500$ psi $M_r=660$ psi for $f'_c = 4000$ psi $M_r=710$ psi for $f'_c = 4500$ psi
Reliability, R	95%	
Initial Serviceability Index, p_o	4.5	
Terminal Serviceability Index, p_t	2.5	
Elastic Modulus, E_c	See comment <div style="border: 2px solid black; width: 100px; height: 20px; margin: 5px 0;"></div>	Dependent upon required concrete strength $E_c=3.6 \times 10^6$ psi for $f'_c = 3000$ psi $M_r=3.8 \times 10^6$ psi for $f'_c = 3500$ psi $M_r=4.0 \times 10^6$ psi for $f'_c = 4000$ psi

AASHTO Design Parameter	Design Value	Comments
Friction Factor, F	1.8	$M_r=4.2 \times 10^6$ psi for $f'_c = 4500$ psi Lime, lime-fly ash, asphalt or cement stabilized subgrade

Harris County Engineering Department specified design parameters for flexible paving designs based on available traffic data are:

AASHTO Design Parameter	Design Value	Comments
Reliability, R	95%	
Standard Deviation, S_o	0.45	
Soil Resilient Modulus, M_r	30,000 psi	$M_r = 1500 \times \text{CBR}$; CBR estimated as 20 for stabilized subgrade
Drainage Coefficient, m_2 m_3	1.25	AASHTO Table .24 - good quality drainage (1% - 5%) - drains within 1 day
Initial serviceability index, P_o	4.2	
Terminal serviceability index, p_t	2.5	
Structural layer Coefficients		
Hot-mixed hot-laid asphalt surface material	0.44	
Black base	0.34	
Cement-stabilized limestone	0.23	
Lime-stabilized limestone	0.17	
Crushed recycled concrete	0.14	
Raw limestone	0.14	
Cement-stabilized earth	0.15	
Lime-stabilized or lime-fly ash stabilized earth	0.11	

AASHTO Design Parameter	Design Value	Comments
Minimum acceptable recommended thickness		
Surface course	2 in.	
Base course	4 in.	
Sub-base course	4 in.	

SECTION 7.03 – MATERIALS REQUIREMENTS

The following requirements shall apply to paving subject to the jurisdiction of the Harris County Engineering Department:

1. The concrete mix design shall be either of the following options:
 - A. A mix design containing five (5) sacks of cement per cubic yard with no Fly Ash allowed; or
 - B. A mix design containing Fly Ash and cement that has cementitious content of not less than five and one half (5 ½) sacks per cubic yard. The Fly Ash content shall not exceed twenty-five percent (25%) by weight.
2. All concrete pavement shall have a minimum design and in place compressive strength of 3000 psi at twenty-eight (28) days.
3. Concrete for major thoroughfares shall meet the design determined by the AASHTO design required in Section 7.02 B, above.
4. Minimum reinforcing for Local, Collector, and Major Thoroughfares shall meet the size, strength, and spacing shown in Table 7.3 following:

TABLE 7.3

**REINFORCING STEEL BAR SIZES AND SPACING
FOR VARIOUS PAVEMENT THICKNESS (D) AND WIDTH (W) WITH:
EXPANSION JOINT SPACING = 80 FT (MAXIMUM)
fc' = 3,000 PSI AND fy = 60,000 PSI**

	LONGITUDINAL STEEL	TRANSVERSE STEEL
PAVEMENT	# 4 BARS	# 4 BARS

THICKNESS D (IN)	PAVEMENT WIDTH (FT)	NUMBER OF BARS	SPACING (IN)	END BAR SPACING (IN)	SPACING (IN)
6	28	17	20.50	4	36
7	25	17	18.25	4	36
7	35	24	18.00	3	36
7	36	25	17.75	3	36
7	37	25	18.25	3	36
7	41	28	18.00	3	36
7	45	31	17.75	3	36

MAJOR THOROUGHFARE

PAVEMENT THICKNESS D(IN)	LONGITUDINAL STEEL			TRANSVERSE STEEL	
	#5 BARS			#5 BARS	
	PAVEMENT WIDTH (FT)	NUMBER OF BARS	SPACING(IN)	END BAR SPACING (IN)	SPACING(IN)
10	25	44	18	3	36
10*	25	86	9	3	36

*Applies to major thoroughfare paving with one hundred sixty feet (160') expansion joint spacing only.

**Reinforcing steel bar size and spacing for eight inch (8") pavement thickness to be designed by the engineer.

A. Minimum lap length for #4 reinforcing steel shall be twenty-two inches (22"). Minimum lap length for #5 reinforcing steel shall be twenty-four inches (26"). For all cold construction joints, use four-foot (4'), Grade 40 L-bars spaced at 24-inch centers through the deformed metal strip.

B. Expansion joints in cul-de-sacs and knuckles shall be placed as shown in Appendix "I".

5. Asphalt

Hot mix asphalt shall meet the requirements of "Harris County Standard Specification, Item No. 250 and 340". (Complete Harris County Standard Specifications are available online at www.eng.hctx.net).

6. Base Course Requirements

- A. Cement stabilized crushed aggregate base course shall meet the requirements in “Harris County Standard Specification, Item No. 231” except that Section 231.4 is modified so that the base course shall be compacted to 95% Standard Proctor Density, ASTM D-698.
- B. Hot mix asphaltic concrete base course (black base) shall meet the requirements in “Harris County Standard Specification, Item No. 250.”
- C. Untreated aggregate base shall meet the requirements in Harris County Standard Specification Item No. 230. Placement requirements shall be included in the construction plans, maximum eight-inch (8”) lifts, compacted to 95% Standard Proctor Density, ASTM D-698.

7. Stabilized Subgrade Requirements

The geotechnical engineer shall provide subgrade treatment recommendations including type of stabilizer and anticipated application rate (lb/yd²) to develop the required subgrade density design requirements.

- A. Lime-stabilized subgrade shall meet the requirements outlined in “Harris County Standard Specifications, Item Nos. 220 and 221”.
- B. Portland Cement-stabilized subgrade shall meet the requirements outlined in “Harris County Standard Specification, Item No. 222”.
- C. Lime fly ash or fly ash stabilized subgrade shall meet the requirements outlined in “Harris County Standard Specification, Item No. 223”.
- D. Commercially available products shall meet the requirements of the manufacturer and the geotechnical engineer and shall be approved by Harris County Engineering Department.

SECTION 7.04 – SPECIFICATION REQUIREMENTS

- 1. Pavement shall be constructed in accordance with “Harris County Standard Specification, Item No. 360”, as modified below, for all privately funded local and collector-roadway projects.

- A. Section 360.13, is hereby modified to allow the use of a metal center strip in lieu of saw cutting the center longitudinal contraction joint.
- B. Section 360.8, is hereby modified to allow the use of wood forms for six-inch (6") and seven-inch (7") pavement sections. The bottom flange of steel forms shall be two inches (2") or more. If other commercially available types of forms are used they shall be installed in accordance with the manufacturer's suggested method and meet the approval of the design engineer and Harris County Engineering Department.
- C. Section 360.10,11, and 12, is hereby modified to allow placement at contractor's responsibility based upon equipment sequence utilized in accordance with recommendations and practices of ACI 304.
- D. Section 360.19 Deficient Pavement Thickness, is hereby modified as follows:

It is the intent of Harris County to receive and accept streets and roads into the County's System of Maintained Roads that are constructed in strict conformity with the paving thickness shown on the approved construction plans.

Pavement that is constructed and cored in accordance with this specification shall be acceptable if the measurement of any core is not deficient by more than 0.30 inches from the thickness shown on approved construction plans.

If a core shows the pavement to be deficient in thickness by more than 0.30 inches but less than 0.5 inches, the following procedure may be followed:

1. Additional cores for deficient pavement thickness will be taken at ten-foot (10') longitudinal intervals and at random locations transversely on each side of the deficient core until a core is taken that is acceptable. If the new cores on either side of the deficient core are acceptable and the average of the three cores is not more than 0.30 inches less than the original plan thickness, the pavement is acceptable.
2. If the average of the cores in (1), above, is not acceptable, then additional cores shall be taken until an acceptable core is found on each side of the original deficient core. All concrete between the two acceptable cores shall be removed and replaced to the centerline joint.
3. All cores shall be from the same pavement pour.

Any core that is deficient by 0.5 or more inches is unacceptable. If a core is unacceptable then take additional cores out of the same pour on each side of the deficient core at ten-foot (10') intervals until the pavement thickness is found to be acceptable as stated above. All concrete between the two acceptable cores shall be removed and replaced to the centerline joint.

- A. All references to Harris County Specification requirements contained in this document pertain to the technical provisions of the specifications and not to the measurement and payment provisions therein.
- B. Section 360.12 is hereby modified to allow use of fly ash in lieu of retarder up to a temperature of 97° if approved.

Major thoroughfares shall be constructed in accordance with Harris County Standard Specification 360.12.

SECTION 7.05 - GEOMETRIC REQUIREMENTS

- 1. Curb and Gutter Sections
 - A. The minimum gradient on gutters shall be 0.30 percent.
 - B. The maximum drop of grade tangents from opposite directions to a common inlet shall be 1.5 feet.
 - C. The maximum allowable curb run to an inlet shall be seven hundred feet (700') in one direction for residential streets and three hundred feet (300') in one direction for major thoroughfares or streets within commercial developments.
 - D. There shall be a minimum one percent (1%) fall around intersection turnout for a minimum radius of twenty-five feet (25'). The grade for larger radius shall be determined on an individual basis.
 - E. Vertical curves shall be installed when algebraic difference in grades exceeds one percent (1%). Elevations shall be shown at ten-foot (10') intervals through vertical curves. A minimum differential of 0.03 feet (0.03') on ten foot (10') intervals shall be maintained by altering the calculated elevations.
 - F. The required radius of cul-de-sac pavement is as follows:

- (1). Residential radius shall be a minimum of forty-two feet (42') to face of curb, and
 - (2). Commercial radius shall be a minimum of fifty feet (50') to face of curb.
- G. Unless otherwise directed by the County Engineer, when a curb and gutter intersects a drainage ditch, the grade of the gutter must be above the designed water surface of the ditch in accordance with requirements of the Harris County Flood Control District.
- H. The minimum grade for cul-de-sac shall be 0.60 percent along gutter.
- I. All major thoroughfares with a center line radius of lanes or rights-of-ways less than two-thousand feet (2000') will require a variance that shall be reviewed and approved by the County Engineer.
- J. Super-elevation should not be used except with prior approval by the County Engineer. Where super-elevation is used, it should be based on sound engineering practice and in accordance with the latest edition of AASHTO's, "A Policy on Geometric Design of Highways and Streets."
- K. For boulevard sections, the amount of cross slope over the pavement section shall be shown on the plans. The usual cross slope is one-fourth inch (1/4") per foot from curb line to curb line, and one-eighth inch (1/8") per foot for turn lanes and esplanade crossovers.
- L. For streets with single paving sections, the amount of cross slope over the pavement section shall be in accordance with Harris County Drawing S/D-1, "Subdivision Pavement Standards."
- M. A minimum gradient of 0.40 percent around the longest radius is required on an L-type street intersection.
- N. All grades shall be laid to match the top of the curb of an existing inlet.
- O. When the curb grades are not laid below the natural ground, fill lines shall be shown on the plans and shall be of a sufficient height to ensure a minimum of three-eighths inch (3/8") per foot transverse slope toward the curb from the property line between

a point two feet (2') outside the right-of-way and the top of the curb. If this type fill is required and the pavement is adjacent to a non-participating property owner, fill easements from this property owner must be obtained and filed. A copy of the recorded easement document shall accompany the final plans.

- P. All grades shall be labeled for all top of curbs except at railroad crossings. Centerline grades are only acceptable for approved streets with ditch sections.
- Q. Gutter elevations are required for vertical curves where a railroad track is being crossed.
- R. The gradient for tangents to vertical curves at railroad crossings shall be a maximum of three and one-half percent (3.5%) and four percent (4%) at bridges, box culverts, and pedestrian tunnels.
- S. Where railroad crossings are not at right angles to the pavement slab, vertical curves should be calculated for each curb line and should be posted at ten-foot (10') intervals in the profile.
- T. Valley Gutters are not permitted.

2. Roadway Sections with Ditches

- A. The minimum grade on ditches shall be one percent (1.0%). If ditches exceed 4 feet in depth, with side slopes steeper than 5 to 1, guard rails shall be required or ditches piped unless an alternative design meeting the intent of this section is submitted and approved.
- B. The ditch shall be designed to handle runoff as determined in Section 6.02 "Design Requirements", above.
- C. The side slopes of ditches shall not be steeper than a ratio of 3:1 for unimproved ditches. Steeper slopes may be allowed when existing right-of-way is limited or other construction features dictate the design. Prior written approval by the Harris County Engineering Department shall be obtained for steeper slopes.
- D. All culverts shall be designed to carry ditch discharge. The minimum culvert size shall be eighteen inches (18"). All driveways shall have culverts or bridges.

3. Curbs

- A. The standard curb height for residential streets is either the standard six-inch (6") curb or a four-inch by twelve-inch (4"x12") roll-over curb configuration. Islands shall be constructed only with a six-inch (6") standard curb height in accordance with Harris County Drawing S/D-1, "Subdivision Pavement Standards."
- B. Curbs are to be decreased from six inches (6") to two inches (2") in ten feet (10') when approaching railroad tracks, an existing roadway without curbs, or channelized turn lanes.

4. Sidewalks and Driveways

- A. All sidewalks and driveways shall conform to the latest revision of the "Regulations of Harris County for the Construction of Driveways and Culverts on County Easements and Rights-of-Way" and in accordance with the requirements of the Texas Department of Licensing and Regulation (TDLR).
- B. Paved median noses shall be six inches (6") thick with surface colored black for concrete pavement and uncolored for asphalt pavement, a minimum of six feet (6') deep measured from the end of the median nose and the curbs are at least four feet (4') in width face to face. This requirement is imperative for all median noses.
- C. If sidewalks are proposed, curb ramps shall be provided to connect to adjacent sidewalks and shall be designed in accordance with the requirements of the Texas Department of Licensing and Regulations (TDLR) and standard details as promulgated by the County Engineer.

5. Requirements for Intersections, Turnouts, Transitions, and Thoroughfares

- A. At a "T" intersection with a street that has not been improved to its ultimate width, concrete pavement should be stopped either

at the right-of-way line or the end of the curb return, whichever would require less concrete removal at a future date.

- B. When roadway turnouts are placed where an existing cross street intersects, the turnout should be sized to fit the ultimate pavement width and then transitioned to the existing roadway utilizing the same materials as exist on the existing road/street. The length of transition shall conform to “Geometric Guidelines for Subdivision Streets, Harris County, and City of Houston,” (and any subsequent revisions thereto) as adopted by Commissioners’ Court on July 28, 2009, and the latest edition of the “Texas Manual on Uniform Traffic Control Devices” (TMUTCD) with Revisions.
- C. When paving only one (1) side of a proposed divided thoroughfare, all left turn lanes and median crossovers in the one-half (1/2) of the right-of-way where the roadway is being paved shall be paved to the center line of the street right-of-way except at street intersections where turnouts should be constructed for both halves of the boulevard.
- D. When meeting an existing concrete street at right angles, the existing street shall be saw cut in a V-shape extending from the curb returns to a point where the center line of the proposed pavement intersects the quarter point of the existing street in order to create a crowned intersection. In the event that this construction would cause an excessively rough riding condition which would make adequate control of the vehicle difficult, a special design will be considered to eliminate this condition.
- E. All traffic signs, striping, channelization devices, etc., must comply with the latest edition of the “Texas Manual on Uniform Traffic Control Devices” (TMUTCD) with Revisions.
- F. Prefabricated pavement markings on major thoroughfares and major thoroughfare modifications shall be placed in accordance with Harris County Standard Specifications, Item Nos. 666 and 669.

6. Miscellaneous Paving Requirements

- A. If driveways are to be constructed with the paving project, show the driveways on the plans and post a center line for the driveway at the property line with elevation for each drive.
- B. Private streets shall be treated as if they were driveways, and the sidewalk area should be honored with no curb extending through this area unless the private street is constructed to public street standards, including curb ramps.
- C. Load transfer devices shall be placed at the end of all concrete streets and protected from corrosion.
- D. All concrete that must be removed shall be removed either to an existing expansion joint or a sawed joint.
- E. Crest vertical curves shall provide sight distance in accordance with the design speed; however, a minimum forty-five (45) MPH sight distance must be maintained for all major thoroughfares, and forty (40) MPH sight distance must be maintained for all other crest vertical curves
- F. Barricades which meet the Harris County requirements (Type III) must be placed at the end of all dead-end streets that do not terminate in a cul-de-sac.
- G. Prior to final acceptance of the improvements by Harris County, the owner of the development must furnish and install the street name signs for all intersections. The street name signs shall be standard Harris County type signs having a green background with white lettering and complies with the "Texas Manual on Uniform Traffic Control Devices" (TMUTCD) with revisions required.
- H. A letter of agreement from the entity approving the construction plan crossing is required when paving is placed over a transmission pipeline.
- I. Horizontal tie bars are required when meeting concrete pavement that has no exposed steel and further:

- (1). The tie bars shall be #6 bars, twenty-four inches (24") long, twenty-four inches (24") center to center, embedded twelve inches (12"), and epoxied; and
 - (2). As an alternate to (1) above, the existing pavement may be saw cut and removed to expose a minimum of twelve inches (12") of steel (longitudinal) to the new construction with an equivalent cross section area of steel equal to the proposed pavement steel.
- J. All guidelines set forth in the latest edition of "Texas Manual on Uniform Traffic Control Devices" (TMUTCD) with Revisions shall be strictly followed.
- K. "Cold" joints in pavement are prohibited.
- L. Pavement marking and sign placement details shall be shown on the plan and profile sheets or on separate plan sheets.

SECTION 8.0 – STRUCTURES AND BENCHMARKS

1. The inclusion of bridges or other ditch type crossings may be required as part of a project in order to maintain a smooth flow of vehicular traffic through any given area. In the event uncertainty exists concerning whether or not a bridge will be required, it is advisable to contact the Harris County Engineering as soon as possible so that the issue can be resolved while the project is in the planning stage.

For all bridges and similar crossings that are to be constructed within the jurisdiction of Harris County, the following requirements shall apply:

- A. All bridges and box culverts to be designed to minimum HL-93 loading or AASHTO “LRFD Bridge Design Specifications” as applicable load design.
- B. Bridge Widths
 - (1) Where there are no curbs on the approach pavement to the bridge, the width of the bridge (face to face of curbs) shall be out to out distance of the approach road pavement edges plus two feet (2’) each side, plus the walk or walks. The sidewalks shall be four-foot (4’) clear width type.
 - (2.) Where there are curbs on the approach pavement to the bridge, the width of the bridge (face to face of curbs) shall be the same as the distance between curb faces on the approach road. The sidewalks shall be six-foot (6’) clear-width type.
- C. Individual one way traffic bridges on median boulevards shall have one walk on the outside of either side of the bridge and two way traffic bridges shall have a walk on each side of the bridge.
- D. All bridges shall be of reinforced concrete design unless specific application require other materials and then only with prior approval of the Harris County Engineering Department.
- E. All bridge railings shall be galvanized or stainless steel on reinforced concrete parapet walls.

- F. All galvanized Flex Beam Guard Rails shall be designed and constructed in accordance with the Harris County Engineering Department drawing titled “Flex Beam Guard Rail Detail”.
 - G. All design and construction shall be in conformance with “Harris County Standard Specification Item No. 420, Concrete Structures” and all other applicable Harris County specification items.
 - H. Where culverts are used as a bridge, the headwall shall be of a sufficient height to allow construction of the guardrail and sidewalk at the elevation of the roadway.
2. The inclusion of a new permanent benchmark is required for the following projects and shall be clearly indicated on the construction plans for the proposed location:
- A. All new or substantially repaired bridges that are designed for public vehicular traffic. The benchmark shall be located at the midway point on the downstream side of the bridge.
 - B. New residential subdivisions with the following exceptions:
 - (1) Where the entire subdivision is located further than one mile outside of the current Flood Insurance Rate Map 1% (100-year) floodplain boundary.
 - (2) Where the subdivision is located within one mile of an existing Harris County reference mark and that mark has been recovered within the past 365 days. Station recovery data forms are available through the Harris County website: <http://www.harriscountyfrm.org>.
 - (3) Permanent physical markers shall be provided so each lot owner has access to, or visibility of, the Floodplain Easement, if any, on a lot.

New benchmarks shall be located on top of the concrete over a BB inlet, or on the concrete at the nose of a median in the center of the road.

The benchmark shall be established upon a permanent structure, or may be set as a monument, and shall be readily accessible and identifiable on the ground.

All required monuments, markers and benchmarks shall be in place prior to the County's acceptance of any street improvements.

- C. Refer to Appendix J for requirements for setting new benchmarks, submittal and acceptance procedures.

SECTION 9.0 - TESTING REQUIREMENTS

SECTION 9.01 GENERAL

1. All construction materials shall be tested and monitored by an A2LA or AASHTO accredited laboratory.
2. All construction materials shall be tested and monitored in accordance with provisions referenced in Section 7.04.
3. Any engineering technician performing testing in accordance with these rules shall be proficient for the type of testing required as deemed by the engineer-in-charge of the accredited laboratory.
4. Upon completion but prior to the acceptance of the work by Harris County Engineering Department, the accredited materials engineering laboratory shall submit to the Harris County Engineering Department a written statement of substantial compliance sealed by a professional engineer licensed in the State of Texas. The written statement of substantial compliance must acknowledge that all construction materials and operations used in the project were tested and inspected by accredited laboratory and that they comply with all the specifications applicable to the project.

SECTION 9.02 - BEDDING AND BACKFILL

1. The testing of materials used for bedding and backfill of storm sewers as well as other utility located underneath or within one-foot (1') of subgrade shall be conducted to ensure compliance with "Harris County Standard Specification No. 430" and the project specifications.
2. In construction applications where utilities under the pavement on knuckles and/or cul-de-sacs exist, a special geotechnical note shall be

placed on the geotechnical certification page detailing the method of stabilization and backfill used to meet Harris County Standard Specifications for these applications.

SECTION 9.03 - SUBGRADE TESTING

1. All paving subgrade shall be proof-rolled after the roadway has been cut to grade. The Design Engineer, Accredited Laboratory, or their designated representative shall monitor proof-rolling operations and shall determine whether remediation of weak areas is required before subgrade treatment. If remediation is required, the Design Engineer or Accredited Laboratory shall provide recommendations for remediation. The Design Engineer shall determine equipment that is suitable for use during proof-rolling.
2. Samples of the paving subgrade shall be taken to verify the applicability of the recommended stabilization type and quantities. The Accredited Laboratory shall determine the frequency of sampling. The Accredited Laboratory shall confirm that the stabilizer type and application rate provided in the plans and specifications is appropriate or shall provide the appropriate stabilizer type and application rate based on laboratory testing of the paving subgrade.
3. Density tests shall be performed every 300 linear feet of chemically treated subgrade. Closer spacing for density testing may be required to verify conformance with project specifications.
4. In the event of rainwater standing on the subgrade after densities are made or other conditions beyond the contractor's control, and if the Design Engineer deems that the subgrade condition has been adversely affected, proof rolling of the subgrade will be required if reinforcing steel has not been placed. In the event that reinforcing steel is present, in-place densities will be performed; however, the Design Engineer may request that the steel be removed and the subgrade subjected to proof-rolling.
5. A minimum of three (3) in-place density tests per street are required.
6. The contractor is required to have copies of treated subgrade density test reports in his/her possession at the construction site at the time of placement of base material. The test date shall be clearly marked on the test reports.

SECTION 9.04 - FLEXIBLE BASE

1. All base material shall be from an approved Texas Department of Transportation (TxDOT) supplier or supplier approved by the Design Engineer.
2. A minimum of three (3) density tests per street are required to verify conformance of compaction to the project specifications.

SECTION 9.05 - SURFACE COURSE

1. All surface course material shall be provided from an approved TxDOT supplier or supplier approved by the Design Engineer.
2. Testing shall be performed through asphalt cores to verify compaction criteria outlined in the project specifications is met.

SECTION 9.06 - CONCRETE PAVEMENT

1. All concrete shall be provided from an approved TxDOT supplier or supplier approved by the Design Engineer.
2. The testing Laboratory shall review the submitted concrete mixture proportions to ensure the requirements of the project specifications are met.
3. A minimum of four (4) test cylinders shall be made for each 125 cubic yard, or portion thereof, placed each day. Samples shall be taken in accordance with ASTM C 172 and molded and cured in accordance with ASTM C 31. Field tests including measurement of ambient temperature, concrete temperature, slump, and air content shall be made in accordance with the appropriate ASTM test methods, where applicable.
4. All test specimens shall be prepared in accordance with ASTM C 617 and tested in accordance with ASTM C 39. Two (2) specimens shall be tested at seven (7) days and two specimens shall be tested at twenty-eight (28) days. The acceptance test results shall be the average of the two specimens tested for each age interval. If one specimen in a test age indicates evidence of improper sampling, handling, molding or testing, it shall be discarded and the strength of the remaining specimen shall be considered the test result. Should both specimens in a test interval

show any of the aforementioned defects, Harris County may request that cores of the pavement placed in the affected area be re-taken.

5. Additional test specimens may be required due to concrete placing conditions or for adequately determining the strength of concrete when early opening of the paving to traffic is necessary and/or desirable.

SECTION 9.07 - CONCRETE CORES

1. Once the pavement has been in place for a minimum of fourteen (14) days, one core shall be taken for each 1,000 square yards of pavement or portions thereof with a minimum of one core on each street. Cores shall be taken alternately in each one-half section of the pavement. The Design Engineer or the Testing Laboratory Engineer shall select locations of the cores.
2. All cores shall be broken at twenty-eight (28) days in accordance with ASTM C 42. Each core shall meet the minimum compressive strength requirement outlined in the project specifications. If a core fails to meet the minimum strength requirement, additional cores may require testing to meet the aforementioned testing requirements.
3. See Section 7.04 (1)(K), above for a discussion of pavement thickness verification by concrete cores.

SECTION 9.08 - STRUCTURES

1. Testing for bridges and structures shall be in accordance with the project specifications.

SECTION 10 - INSPECTIONS

SECTION 10.01 - CONSTRUCTION INSPECTION

The construction of improvements shall be conducted under the supervision of a licensed engineer who shall ensure that work is performed in accordance with the approved plans. Monitoring shall be performed by the following:

1. The Design Engineer shall provide a qualified onsite inspector throughout the construction project for all significant operations.
2. A construction materials technician proficient in the type of testing being performed as deemed by the engineer-in-charge of the accredited laboratory.
3. An inspector from Harris County.

SECTION 10.02 - NOTICE OF START

The contractor shall notify the Harris County Engineering Department in writing (emails and facsimile acceptable) a minimum of twenty-four (24) hours in advance of the work commencing on the project. The notice shall include the development permit number issued under the “Regulations of Harris County, Texas, for Floodplain Management.” Failure to follow these requirements may result in the County not accepting the paving and drainage facilities for maintenance upon completion.

SECTION 11 - ACCEPTANCE OF IMPROVEMENTS WITHIN SUBDIVISIONS

SECTION 11.01 – ACCEPTANCE PROCEDURES

A project is eligible for initial inspection at such time as the pavement and drainage facilities have been completed and the subdivision plat and required right-of-way or easement instruments have been recorded in the Official Public Records of Harris County.

To schedule an initial inspection and allow homebuilders to obtain development permits in accordance with the *Regulations of Harris County, Texas for Floodplain Management*, the Engineer of Record shall submit the following:

1. A completed “Request for Initial Inspection Form” as promulgated by the County Engineer. An engineer may submit the request electronically via the on-line submittal process. The form shall include the engineer’s, contractor’s, and developer’s e-mail address for contact purposes.
2. A physical copy of the approved plans for the project. These plans shall be stamped record drawings, sealed by a licensed engineer and shall have the following statement. *“This project is constructed in general conformance with these plans and elevations on these plans represent what was constructed within engineering tolerances.”* In cases where Developer builds both halves of a major thoroughfare, the stamped record drawings shall cover both halves.
3. A “Statement of Substantial Compliance Form” as promulgated by the County Engineer demonstrating the project met all testing and performance requirements. An engineer may submit the request electronically via the on-line submittal process.
4. Two physical copies of the recorded plat to scale.
5. A copy of the development permit.
6. A copy of the Financial Surety Worksheet and receipt.

Each homebuilder may obtain one (1) permit for a model home prior to the initial inspection being scheduled and the requirements above being submitted.

When receiving the package and request for initial inspection, Harris County shall issue a receipt indicating what items were received and the date they were received. The online system will be updated by the next business day after receiving the items. Once all items are received, the online system will indicate the date of package completion beginning the 10 day review process. Then Harris County shall respond by one of the following:

1. Determining the package is complete, scheduling the initial inspection, and releasing development permits. No provision in the regulations releases the project parties from meeting Harris County's minimum criteria as adopted in said regulations.
2. Rejecting the package and notifying all parties of required corrections.

Upon the earlier of (1) verification that the submittal documents meet all of Harris County's minimum criteria (2) the passage of 10 business days from package receipt without a rejection or return of the package, homebuilders may obtain development permits, provided that such permits are otherwise authorized in accordance with the *Regulations of Harris County, Texas for Floodplain Management*. Upon completion of the inspection, the County Engineer shall issue a punch list indicating any items that must be addressed prior to the start of the one-year performance period. The engineer must apply for re-inspection and pass the initial inspection within 90 days of the original inspection date. If the engineer has not requested and passed the initial inspection within 90 days of the original inspection date, the County Engineer may, in the interest of the safe, orderly, and healthful development of the unincorporated area of the county and the promotion of the health, safety, morals and general welfare of the county's residents, suspend the issuance of any or all County permits in regard to the subdivision until the initial inspection has been requested and passed. Any inspection requests after 90 days of the previous inspection shall be subject to a complete re-inspection of all facilities. The County will schedule re-inspections within two weeks after receiving a request. Should the County fail to meet any of the time frames outlined in this section, an additional day will be added to the 90 day time frame for every day the County missed the deadline. Once all paving and drainage items are corrected as well as any safety related items, the County Engineer shall issue a Letter of Substantial Completion indicating the improvements appear to meet the approved plans and specifications for the project and specifying the date the project will be eligible for final inspection and acceptance for County maintenance. This date will be one calendar year after the date of the "Passing of the Record Drawing Inspection".

To schedule a final inspection, an engineer shall submit the following:

- 1) Submit the request for inspection electronically via the on-line submittal process
- 2) The developer's executed "Directive for Financial Assurance Form," as promulgated by the County Engineer. This form indicates if the developer wishes the County to release or retain the submitted financial assurance. Should this directive indicate the developer's wish that the County retain the submitted financial assurance, the developer shall be responsible for latent defects only. Should this directive indicate the developer's wish that the County release the submitted financial assurance, less the administrative fees, the developer will be responsible to fix all deficient items. An engineer may fulfill this obligation by submitting the request electronically via the on-line submittal process.

Upon receipt of the above items, the County Engineer shall schedule an inspection notifying the applicable Precinct representative, developer, engineer, and contractors of the scheduled inspection date via e-mail.

After completion of the inspection and any subsequent re-inspections, the County Engineer shall do one of the following in regard to any Financial Surety consisting of cash, provided that the funds have not been forfeited to the County pursuant to a Directive for Financial Assurance Form:

1. Recommend acceptance and authorize release of the financial assurance funds minus the administrative portion in their entirety.
2. Recommend retaining the entire submitted financial assurance funds and not accepting the infrastructure due to material defects in the paving and/or drainage improvements constructed by the developer. If this occurs, the County Engineer shall refer the matter to the County Attorney for legal action providing specific evidence.

Failure to submit the "Request for Final Inspection Form" and the "Directive for Financial Assurance Form" within forty-five (45) days after the one-year anniversary date of the "Passing of the Record Drawing Inspection Date" shall constitute a failure to complete the roads, streets and drainage requirements in accordance with these regulations and within a reasonable time. This shall be considered a violation of a condition of the financial surety, resulting in a hold being placed on the subdivision for additional permits and a referral to the Harris County Attorney for further action.

Failure to complete and pass all inspections within six (6) months after the one-year anniversary date of the “Passing of the Record Drawing Inspection Date” shall constitute a failure to complete the roads, streets, and drainage requirements in accordance with these regulations and the financial surety will be forfeited to Harris County. Harris County may seek further action through the Harris County Attorney’s Office to bring the subdivision into compliance.

SECTION 11.02 - INSPECTION AND RE-INSPECTION FEES

A re-inspection fee in the amount of \$1,000.00 shall be charged prior to scheduling the inspection if any of the following events occurs:

1. An inspection is scheduled when the work proposed on the plans is not completed in its entirety unless such partial inspection is specifically approved prior to scheduling.
2. A re-inspection is scheduled and upon inspection it is determined that the deficiencies previously noted have not been addressed.
3. An inspection or re-inspection is cancelled without giving three (3) working days notice unless affected by severe weather.

In order for a project to be considered ready for inspection, parties must be available to open and close manhole lids and inlet plates upon request and all fire plugs in the upper reaches of the storm sewer system must have been flushed to demonstrate proper flow prior to the start of the inspection. If fire plugs are not present or charged, this requirement may be waived. Failure to do so will result in a \$1,000.00 re-inspection fee.

In no case will the developer be held responsible for work covered under the “Regulations of Harris County for the Construction of Driveways and/or Culverts” as applicable unless the developer was the permittee. The permittee under those regulations will be held responsible for deficient work. The developer will only be held responsible for latent defects if they release the Financial Surety for deficient work.

SECTION 12 - TRAFFIC

SECTION 12.01 – Traffic Definitions:

1. Major Thoroughfares – Long, continuous facilities that are designed to carry high volumes of traffic and generally serve as high volume travel corridors that connect and provide access to commercial, mixed use, and residential areas.
2. Collector – Roadways that carry moderate volumes of traffic. Collectors can be classified as major or minor, depending on the type of facilities to which they are connected, length, type of surrounding land use, and existing and/or projected traffic volume and characteristics. These facilities typically have the primary function of carrying traffic from local roadways or other collectors to intersections with like and/or higher class facilities.
3. Local – Roadways that carry low volumes of traffic local to a given area. These facilities are typically very short (less than one (1) mile in length). Their primary function is to provide access to homes and businesses and, where applicable, accommodate on-street parking and pedestrian activities.

SECTION 12.02 – LEFT TURN LANES

Left turn lanes shall be required in the following situations:

1. All signalized intersection approaches along Major Thoroughfares and Collectors, planned or existing;
2. All unsignalized intersections and driveways along divided Major Thoroughfares and Collectors, planned or existing;
3. All unsignalized intersections and driveways along undivided Major Thoroughfares, and Collectors planned or existing;
4. All developments with an overall footprint in excess of five (5) acres located within 500 feet of the intersection of two or more thoroughfare facilities (i.e., Major Thoroughfares, and/or Collectors as defined by the City of Houston Major Thoroughfare and Freeway Plan);

5. New public or private school construction;
6. Shopping centers and other traffic generators with a lease space in excess of one hundred thousand (100,000) square feet;
7. Places of worship.

It should be noted that the preparation of a Traffic Impact Analysis is strongly encouraged for all midsize and large developments. Furthermore, a Traffic Impact Analysis may be required, as a condition for review and/or acceptance, if it is determined by the Harris County Engineering Department that the development has the potential to impact regional transportation facilities and/or has a regional impact on traffic patterns, such as schools. A traffic impact analysis is required for the evaluation of requests for variances and/or deviations from Harris County Design and Development Guidelines. If the developer or engineer feels a left turn lane is not warranted, he/she shall submit a Traffic Impact Analysis to support any request for a variance of the left turn lane.

Turn lanes shall meet the criteria outlined in Section 7 - Paving. The paving design requirements shall be the same as the adjacent main traveled lane requirements.

When asphalt roadways are widened to accommodate left and right turn lane installations, the entire roadway shall be overlaid from beginning to ending of the widening transitions.

SECTION 12.03 - ROADSIDE SIGNS

Roadside signs shall be in accordance to latest edition of the "Texas Manual on Uniform Traffic Control Devices" (TMUTCD) with Revisions, and Harris County Standard Details and Design Specifications.

SECTION 13 - LANDSCAPING

SECTION 13.01 - LANDSCAPE POLICY

The purpose of these Rules is to protect the public, to maintain safe and efficient operating regulations, and to preserve and maintain the integrity of Harris County roads and road drainage easements and rights-of-ways, during

the construction, maintenance and/or repair of landscaping or placing of vegetation.

SECTION 13.02 - USE OF TERMS:

- A. **“Landscaping”** means the placement of trees, shrubs, or plants for the purpose of beautification of an esplanade(s) or other portion(s) within a County right-of-way.
- B. **“Visibility Triangle”** means the triangular area adjacent to the intersection of any street established by measuring a distance of twenty-five (25) feet for Major Thoroughfare and Collector Street and fifteen (15) feet for Local Street from the point of intersection of two streets along the right-of-way of each of the intersecting streets and connecting the ends of each measure distance to assure adequate visibility sight lines for vehicular traffic approaching the intersection. In these areas, landscaping shall be no greater in height than thirty (30) inches above top of adjacent curb or centerline of pavement when allowed to grow to its maximum height.
- C. **“Specimen Tree”** means an exemplary tree of good health and true to species habit and form, containing a minimum caliper of 1 ½ inches.
- D. **“Caliper”** means the minimum diameter of a tree as measured six (6) inches above the ambient grade for trees up to and including four (4) inches in diameter, twelve (12) inches above the ambient grade for trees having a diameter exceeding four (4) inches but not exceeding eight (8) inches and fifty-four (54) inches above the ambient grade for trees having a diameter greater than eight (8) inches.

SECTION 13.03 - CONSTRUCTION ACTIVITY

No person shall enter upon land acquired, claimed or maintained by Harris County for road and/or road drainage for the purpose of placement or modifications of landscaping until the County Engineer certifies that all requirements have been met.

SECTION 13.04 - PROHIBITED ACTIVITY

No person shall place landscaping in such a manner as to interfere with the construction, maintenance and/or repair of any County road, ditch or right-of-

way. In the event that any such facility interferes in any manner with the construction, maintenance and/or repair of any County road, the person, company, or other entity in control of the landscaping shall alter it no later than thirty (30) days after notice from the County Engineer and bear the cost and expense of any change or alteration.

No person shall place landscaping in such a manner as to interfere with the use of or obstruct vehicular or pedestrian traffic on any County road or drainage on or along such road. No landscaping higher than thirty (30) inches shall be placed in the visibility triangle.

No person shall place landscaping in such a manner as to constitute a danger or hazard of any kind to persons or vehicles using or maintaining such road, or any public property located within the boundaries of the County right-of-way.

The operation of construction equipment on the traveled surface of any improved County road is prohibited unless the placement of landscaping cannot be accomplished by any other method. In such instances, the equipment shall use rubber tires on said traveled surfaces unless other methods are approved.

SECTION 13.05 - TREESCAPE AND SCREENING REQUIREMENTS FOR COMMERCIAL ESTABLISHMENTS AND PUBLIC BUILDINGS

The following requirements apply to all commercial and public buildings constructed or substantially redeveloped after the effective date of these regulations.

“Public Buildings and Commercial Establishments” include any building where the public may gather or where goods or services are provided for compensation. This definition includes, but is not limited to, auditoriums, classrooms, churches, libraries, restaurants, theaters, schools, daycare facilities, nursing homes, hospitals, correctional facilities, hotels, motels, dormitories, department stores, shopping centers, doctor offices, general offices, laundries, apartment complexes and warehouses. Not included in this definition is an industrial facility having a fire brigade that conforms to requirements of the Occupational Safety and Health Administration or apartment buildings.

Public Buildings and Commercial Establishments (PB&CE) Requirements: Each PB&CE fronting a public road shall be required to plant trees and shrubs in accordance with the schedule listed below. A landscape design and compliance review sheet as promulgated by the County Engineer shall be

submitted for review with each site plan for a proposed PB&CE. Nothing in these regulations shall be construed as restricting such authority as the County may have to remove or require the removal of any landscaping within the right-of-way, whether or not constructed or maintained in conformance with these regulations.

Street Trees:

The required number of street trees is derived by dividing by thirty (30) the total length of all public street frontage measured in feet. Street trees are required adjacent to all public streets, and the required number of street trees must be planted along said frontage on private property and within ten (10) feet of the property line. Exceptions may be granted in instances where trees would encroach into a visibility triangle. Said trees shall be a minimum of 1.5 caliper inches in size and from the approved list found in Appendix “A” of Chapter 33 of the City of Houston Code of Ordinances in effect at the time of adoption of these regulations. If the development is part of a larger planned development, then its pro rata share of street trees shall be provided. Street trees shall be located on private property within ten feet of the adjacent property line fronting the public right-of-way. This planting area can be increased in cases where encroachment into a visibility triangle would create a safety hazard. The required trees may be placed in the adjacent County right-of-way to fulfill this requirement provided the following conditions are satisfied:

1. Such planting is approved by the respective County Commissioner’s designee.
2. Restrictive covenants exist to provide for the maintenance of said trees with no County involvement.
3. Trees are planted in such a manner that they do not create a traffic hazard or a potential to damage the sidewalk or street pavement.
4. Trees planted beneath a utility line shall not have a mature height of greater than 25 feet.

Parking Lot Trees:

To calculate the number of required parking lot trees: determine the number of parking spaces: divide by 10; and round up or down, unless less than one. A minimum of one tree shall be provided. Said trees shall be a minimum of 1.5 caliper inches in size and located within 120 feet of each parking space. These trees shall be from the approved list found in Appendix “A” of Chapter 33 of the City of Houston Code of Ordinances in effect at the time of adoption of these regulations.

Parking Lot Shrubs:

Each development fronting a public street shall have a shrub barrier planted along the perimeter of the parking lot to screen the parking area from the public street. The shrubs shall be a minimum of 18 inches in height and shall be selected from the City of Houston’s approved shrub list found in Appendix “D” of Chapter 33 of the City of Houston Code of Ordinance in effect at the time of adoption of these regulations. The number of shrubs required is equal to ten times the number of street trees. No less than 75% of the shrubs required under this section shall be planted along the perimeter of the parking lot adjacent to the public street.

Buffer Requirement:

Any new commercial or public building proposed adjacent to existing single family residential property shall provide a landscape buffer. An amenity feature constructed within the subdivision is exempt from this requirement. Acceptable buffers include:

- a. A minimum of a six (6)-foot tall wood or masonry fence.
- b. Evergreen plants capable of forming a year round screen of at least six feet in height within three years of installation.

The buffer shall extend the entire distance between the existing single-family residential development and the proposed public building or commercial establishment or its pro rata share if it is a part of a larger development. Pathways may be allowed through the buffer on a case-by-case basis.

SECTION 13.06 - TREE PLANTING REQUIREMENTS FOR SINGLE FAMILY RESIDENTIAL LOTS

The following requirements apply to all single-family lots platted and recorded after the effective date of these regulations. Nothing in these regulations shall be construed as restricting such authority as the County may have to remove or require the removal of any landscaping or plantings within the right-of-way, whether or not constructed or maintained in conformance with these regulations. Every lot greater than 5,000 sf in size shall require that a minimum of two 1.5 inch minimum caliper trees are planted in the front yard. Every lot smaller or equal to 5,000 sf in size shall require a minimum of one 1.5 caliper tree be planted in the front yard. These trees shall be planted prior to occupancy of the residence. The trees must be selected from the City of Houston’s approved tree list found in Appendix “A” of Chapter 33 of the City of Houston Code of Ordinances in effect at the time of the adoption of these

regulations. These requirements shall appear on the face of the plat and in the restrictive covenants of the subdivision. The required trees may be placed in the County right-of-way to fulfill this requirement provided the following conditions are satisfied.

1. Such planting is approved by the respective County Commissioner's designee.
2. The restrictive covenants are structured to provide for the maintenance of said trees with no County involvement.
3. The trees are planted in such a manner that they do not create a traffic hazard or a potential to damage the sidewalk or street pavement.

SECTION 13.07 – PRESERVATION OF EXISTING TREES

Existing trees that are preserved and meet all these requirements may be counted towards part or the entire tree requirement on a caliper inch basis for any trees required by these regulations.

SECTION 14 – VARIANCES

If any person wishes an exception to any provision of these Regulations, such person shall request a variance in writing from the Harris County Engineering Department setting forth the provision(s) from which the variance is sought and why the requested variance is needed. Such person must also explain how equivalent measures to the provision(s) from which a variance is sought will be provided or why the requirement(s) in the regulations is not applicable to such person's project. The Harris County Engineer shall hold a hearing, and deny or grant the variance. The Harris County Engineer may approve a request for variance to these Regulations based on sound engineering practice. Variances will be granted only if the conditions of Section 60.6 of the Title 44 of C.F.R. are met. Specifically:

- (a) The applicant has shown good and sufficient cause.
- (b) It has been determined that failure to grant the variance would result in an exceptional hardship to the applicant.
- (c) The granting of a variance will not result in an increased flood height, additional threats to public safety, extraordinary public expense, or create nuisances, cause fraud or victimization of the public.

- (d) Variances shall only be issued upon a determination that a variance is the minimum necessary considering the flood hazard to afford relief.

Economic hardship shall not constitute the sole basis for granting a variance. If a variance is granted, the person requesting such variance shall conform to all applicable provisions of these Regulations except the Sections for which a variance is granted.

SECTION 15 – VESTED RIGHTS

Subject to Local Government Code § 245.004(9), the rights to which a permit applicant is entitled shall accrue are as follows:

1. Projects with a completed or unexpired administratively complete application for Preliminary Plat submitted (does not include General Plans) to Harris County or a municipality on or before midnight of the effective date of the most currently amended Regulations provided that the project is not Substantially Modified, or
2. An administratively complete development permit application that is submitted to the County Engineer on or before midnight of the effective date of the most currently amended Regulations provided the project is not Substantially Modified, or
3. An administratively complete submitted drainage report for a development project to the County Engineer on or before midnight of the effective date of the most currently amended Regulations, provided the project is not Substantially Modified.

It is the responsibility of the permit applicant to demonstrate a project's entitlement to vested rights under this Section. If a permit applicant believes they are entitled to a vested right, that determination is to be completed prior to the filing of an administratively complete permit application, plat application, or development plan application.

Dormant projects as defined under Texas Local Government Code Section 245.005 are subject to review under these Regulations.

If no progress has been made towards completion of a project, the project will be deemed a Dormant Project and an expiration date of two years from will be placed on the associated Permit. Progress includes any one of the following:

1. an application for a final plat or plan is submitted to a regulatory agency;
2. a good-faith attempt is made to file with a regulatory agency an application for a permit necessary to begin or continue towards completion of the project;
3. costs have been incurred for developing the project including, without limitation, costs associated with roadway, utility, and other infrastructure facilities designed to serve, in whole or in part, the project (but exclusive of land acquisition) in the aggregate amount of five percent of the most recent appraised market value of the real property on which the project is located;
4. fiscal security is posted with a regulatory agency to ensure performance of an obligation required by the regulatory agency; or
5. utility connection fees or impact fees for the project have been paid to a regulatory agency.

Having a permit application, plat application, or development plan application approved under Section 4.09 Vested Rights does not relieve an applicant from the requirement to comply with Texas Water Code 11.086. Harris County's review under Section 4.09 Vested Rights is not intended to impair or impact a property owner's remedies at law or in equity.

SECTION 16 - VESTED RIGHTS DETERMINATION

Any applicant who believes that they have obtained a Vested Right shall submit to the County Engineer prior to the submission of an Administratively Complete permit application, plat application or development plan application, a petition explaining the factual and legal bases upon which the person relies to support the contention that they have a particular vested right and consequently, is exempt or not subject to a particular provision of these Regulations. The petition shall include, at a minimum, the following:

1. The name, mailing address, phone number, and fax number of the applicant (or the applicant's duly authorized agent);
2. Identification of the property for which the person claims a vested right;
3. Identification of the applications for which the applicant seeks relief under this Section;
4. Identification of the "project" as that term is defined in Tex. Loc. Gov't Code § 245.001(3) and the permit application, permit, plat application, plat, development plan application, drainage project, or drainage report that gives rise to the project;
5. Identification of the original application for the first permit in the series of permit required for the project, as described in Tex. Loc. Gov't Code § 245.001(1) and § 245.002(a) & (b) and each subsequent permit application or permit constituting the series of permits, by type of permit and dates filed or approved by the County Engineer;
6. Identification of all pertinent provisions of these Regulations in effect at the time the original application for the permit, plat application or development plan application was filed that (a) the applicant contends control the approval, disapproval of the application for a permit, plat application, or development plan for which relief is sought, pursuant to Tex. Loc. Gov't Code § 245.002(a) & (b);
7. Identification of all the specific provisions of these Regulations that the applicant contends do not apply to the project due to Vested Rights;

Within 15 days of receipt of a petition, the County Engineer shall make a determination as to whether the petition contains the information required above. If the County Engineer determines that the petition is not complete, he must notify the applicant in writing within 5 days of the determination and note the deficiencies. Within 30 days of the receipt of a petition that meets the minimum requirements above, the County Engineer shall render a determination that grants the relief requested in the petition, in whole or in part, or denies the requested relief, in whole or in part. Prior to rendering the

determination, the County Engineer may request a pre-determination meeting with the applicant to discuss the person's Vested Rights claim and may request additional documents or information related to the Vested Rights petition.

If the applicant believes the County Engineer determination is made in error, the applicant may file an appeal with the Hearing Examiner under the provisions of Sections _____. The appeal must be filed within 30 days of the County Engineer's determination.

SECTION 17 – VESTED RIGHTS APPEALS

The term "appellant" is used to refer to the appealing party.

- (a) Vested Rights Appeals are initiated by the filing of an appeal with the Hearing Examiner in writing.
- (b) The Hearing Examiner (Examiner) will set a time for a hearing, which will be scheduled as soon as practicable but within 15 days of the receipt of the written appeal, and shall prepare a Notice of Hearing naming the time and date of the Hearing. Copies shall be distributed as follows:
 - 1. The original copy and the Certificate to Commissioners' Court will be filed with the Clerk of Commissioners' Court and the Clerk will prepare a file for the Hearing Notice.
 - 2. The Examiner will set up his own working or hearing file, in which he will keep one copy.
 - 3. The Examiner will give one copy to the Appellant.
 - 4. The Examiner will deliver one copy to the County Engineer. The Hearing will be conducted as provided in Section 18 below.

SECTION 18 – VESTED RIGHTS HEARING BEFORE THE EXAMINER

At Vested Rights Hearings before the Examiner, the Examiner will hear the testimony of the County Engineer and any witnesses called by the County Engineer. The Examiner will hear the testimony of the appellant and any witnesses called by the appellant. The Examiner will review all documents and exhibits submitted to him by the parties. The Examiner will not be bound by formal rules of evidence and will control the evidence, reserving to himself the

power to exclude testimony or exhibits he does not consider relevant. The Hearing Examiner will maintain an accurate record of the evidence adduced at the Hearing.

SECTION 19 - FILING OF EXAMINER'S DECISION ON VESTED RIGHTS APPEALS

The Examiner will prepare a written decision within 3 working days of the Vested Rights Appeal Hearing. A copy of the Examiner's decision will be filed with the Clerk of Commissioners' Court, the members of the Commissioners' Court and with the County Engineer. The original will be sent to the appellant's address shown on the application.

SECTION 20 - REVIEW OF VESTED RIGHTS APPEAL BY COMMISSIONERS' COURT

If the County Engineer, or the appellant wishes to appeal the Examiner's decision, a written objection must be filed with the Clerk of Commissioners' Court within (10) days of the date the Examiner's decision on vested rights is filed. The Clerk will notify the Hearing Examiner who will place the matter on the Agenda of Commissioners' Court for review at the next meeting of Commissioners' Court. If the objection is filed by the County Engineer, notice that the matter is on the agenda will be sent to the appellant by mail at the appellant's address shown on the permit or application. Commissioners' Court will review the matter. The Commissioners' Court may either affirm or reverse the decision of the Hearing Examiner on vested rights.

SECTION 21 - SEVERABILITY

The provisions of these Regulations are severable. If any word, phrase, clause, sentence, section, provision, or part of these Regulations should be invalid or unconstitutional, it shall not affect the validity of the remaining portions and it is hereby declared to be the intent of the Commissioners' Court that these Regulations would have been adopted as to the remaining portions, regardless of the invalidity of any part.

Appendix A

(As amended by Commissioners' Court Order)

CERTIFICATES REQUIRED ON PLATS OF PROPERTY LOCATED IN THE UNINCORPORATED AREA OF HARRIS COUNTY NOT WITHIN A MUNICIPALITY'S ETJ

Dedicatory language must include the following paragraphs:

FURTHER, Owners do hereby dedicate to the public a strip of land fifteen (15) feet wide on each side of the center line of any and all bayous, creeks, gullies, ravines, draws, sloughs or other natural drainage courses located in said plat, as easements for drainage purposes, giving the City (name of city), Harris County, or any other governmental agency, the right to enter upon said easement at any and all times for the purpose of construction and maintenance of drainage facilities and structures.

FURTHER, Owners do hereby covenant and agree that all of the property within the boundaries of this plat and adjacent to any drainage easement, ditch, gully, creek or natural drainage way shall hereby be restricted to keep such drainage ways and easements clear of fences, buildings, planting and other obstructions to the operations and maintenance of the drainage facility and that such abutting property shall not be permitted to drain directly into this easement except by means of an approved drainage structure.

FURTHER, Owners certify and covenant that they have complied with or will comply with existing Harris County Road Law, Section 31-C as amended by Chapter 614, Acts of 1973, 63rd Legislature and all other regulations heretofore on file with the Harris County Engineer and adopted by the Commissioners' Court of Harris County.

Additional certification on the plat must indicate the floodplain status of the buildable areas on "residential lots" on the plat, referring to the applicable Flood Insurance Rate Map panel and effective date.

A. Buildable Areas Outside the Floodplain:

"I, _____, a Registered Professional Licensed Surveyor in the State of Texas, do hereby certify that the buildable areas for all residential lots are outside [or, are proposed to be outside, based on engineering plans and specifications submitted to the County Engineers Office,] the 100-Year Floodplain as shown on Federal Insurance Rate Map Panel No. [insert panel number] dated [insert effective date of map]. This certification is based solely on plotting boundaries from the FIRM Map, and no technical analysis was conducted."

B. Buildable Areas in the Floodplain

"I, _____ a Registered Professional Licensed Surveyor in the State of Texas, do hereby certify that the buildable areas for all or some of the

residential lots are located within the 100-year floodplain as plotted from the Federal Insurance Rate Map Panel No. [insert panel number] dated [insert effective date of map] and are subject to flooding. The 100-year floodplain is a flood hazard area prone to flooding, and subject to additional floodplain management regulations.”

Floodplain easement dedicatory language must be shown on the plat if a Floodplain Easement is required in accordance with Section 4.07 Floodplain Easements.

”A Floodplain Easement is hereby established over that portion of the effective 100-year floodplain area as delineated from FIRM PANEL No. XXXX dated XXXX within the boundary of this final plat, the limits of which impact the buildable areas of residential lots, wholly or partially, and within such area is prone to flooding. (*See attached sketch.) Construction of any type of residential housing within a Floodplain Easement is subject to additional flood hazard area regulations. A Floodplain Easement may be abandoned by Harris County Commissioners Court if the buildable area of a residential lot is determined to be outside the 100-year floodplain by submitting County Engineer’s Form 1226, with the applicable documentation and fee, to the Office of the County Engineer.

Certificate for Harris County Engineer:

I, John R. Blount, County Engineer of Harris County, hereby certify that the plat of this subdivision complies with all the existing rules and regulations of this office as adopted by the Harris County Commissioners’ Court and that it complies or will comply with all applicable provisions of the Harris County Road Law as amended and all other Court adopted drainage requirements.

John R. Blount, P.E.
County Engineer

Appendix A

Harris County Clerk Certificate of Commissioners' Court Approval:

I, [insert County Clerk name], County Clerk of Harris County and ex officio clerk of the Harris County Commissioners' Court, do hereby certify that the within instrument was approved at a legally convened meeting of the Harris County Commissioners' Court held on _____, 20__ by an order entered into the minutes of the court.

[insert County Clerk name]
County Clerk
of Harris County, Texas

By: _____
Deputy

Harris County Clerk Certificate of Filing:

I, [insert County Clerk name], County Clerk of Harris County, do hereby certify that the within instrument with its certificate of authentication was filed for registration in my office on _____, 200__, at _____ o'clock __.M., and duly recorded on _____, 200__, at _____ o'clock __.M., and at Film Code No. _____ of the Map Records of Harris County for said county.

Witness my hand and seal of office, at Houston, the day and date last above written.

[insert County Clerk name]
County Clerk
of Harris County, Texas

By: _____
Deputy

Appendix B NOTARY FORMATS

- a. For a natural person acting in his or her own right.

STATE OF TEXAS
COUNTY OF HARRIS

This instrument was acknowledged before me on _____ (date) by _____ (name or names of persons acknowledging).

Signature of Notary
NOTARY PUBLIC in and for
The State of Texas

- b. For a natural person as principal acting as attorney-in-fact:

STATE OF TEXAS
COUNTY OF HARRIS

This instrument was acknowledged before me on _____ (date) by _____ (name of the attorney-in-fact) as attorney-in-fact on behalf of (name of the principal for whom the document is signed).

Signature of Notary
NOTARY PUBLIC in and for
The State of Texas

- c. For a partnership acting by one or more partners:

This instrument was acknowledged before me on _____ (date) by _____ (name of the partner or partners signing), partner(s) on behalf of (name of the partnership).

Signature of Notary
NOTARY PUBLIC in and for
The State of Texas

Appendix B

d. For a corporation

This instrument was acknowledged before me on _____ (date) by _____ (name of officer), (title of officer) of (name of corporation), a (state in which incorporated) corporation, on behalf of said corporation.

Signature of Notary
NOTARY PUBLIC in and for
The State of Texas

e. For a public officer, trustee, executor, administrator, guardian, or other representative.

This instrument was acknowledged before me on (date) by (name of the representative signing), as (title of representative) of (name of the entity or persons represented).

Signature of Notary
NOTARY PUBLIC in and for
The State of Texas

Appendix C

Chapter 3 GRAPHIC REQUIREMENTS

3.01 CHAPTER INCLUDES

- A. Graphic requirements for engineering plans.

3.02 REFERENCES

- A. City of Houston monument ties in compliance with Article IV, Chapter 33, City Surveys, of the Code of Ordinances.

3.03 DEFINITIONS

- A. Computer Aided Drafting Design (CADD) - Preparation of drawings, plans, prints, and other related documents through the use of computer equipment and software programs.

3.04 DESIGN REQUIREMENTS

- A. Provide a cover sheet for projects involving three or more design plans (excluding standard City of Houston detail sheets). Plan sheet numbers and titles shall be listed on the cover sheet. Include an area key map and vicinity map to identify project location.
- B. For Design Contracts with the City coordinate with the designated City project manager for sheet size.
- C. Show service area on cover sheet or area map.
- D. Final design plans shall be India ink on mylar, or produced by CADD on mylar using non-water based ink. Do not use adhesive-backed material on final plans. Stick-ons may be allowed with approval of the City Engineer for a minor correction during the final review process.
- E. Details of special structures (not covered by approved standard drawings, such as stream or gully crossings, special manholes, or junction boxes) shall be drawn with vertical and horizontal scales equal to each other.
- F. Each set of engineering plans shall contain paving and utility key drawings indexing specific plan and profile sheets. City Standard Details, where applicable, shall be included. All sheets shall have standard title blocks. Where applicable, show HCFCD key drawings and numbers.
- G. Draw key overall layouts to a minimum scale of 1" = 200'.
- H. Plan stationing must run from left to right, except for short streets or lines originating from a

major intersection, where the full length can be shown on one sheet.

I. A north arrow is required on all sheets and should be oriented either toward the top or to the right. This requirement is waived under the following conditions:

1. A storm water or sanitary sewer with flow from west to east or from south to north.
2. A primary outfall drainage ditch with flow from west to east or from south to north.
3. Stationing is intended to start from the cardinal points of the compass and proceed in the direction of construction.

J. Standard scales permitted for plans and profiles of paving and utility construction drawings are as follows:

1. Major thoroughfares, streets with esplanades over 400 feet in length, or special intersections/situations.

1" = 20' Horizontal, 1" = 2' Vertical

2. Minor or residential single-family streets.

1" = 20' Horizontal, 1" = 2' Vertical

1" = 50' Horizontal, 1" = 5' Vertical, or

1" = 40' Horizontal, 1" = 4' Vertical

3. Scales of Paragraph 3.04J.2 above are minimum; larger scales may be used to show details of construction.
4. Deviation from specified scales can only be permitted with special approval of the City Engineer. For Design Contracts with the City coordinate the required scales on minor streets with the designated City project manager.
5. Single-banked plan-and-profile drawings are acceptable; double-banked plan-and-profile sheets are allowed in certain situations such as off-site utility lines in undeveloped areas.

K. Show ties on drawings to City monuments when applicable; otherwise, make a statement on the cover sheet referencing assumed control coordinates.

L. Each sheet of the plan and profile shall have a benchmark elevation and description defined.

M. The seal, date, and original signature of the Professional Engineer responsible for the plans is required on each sheet developed by the design engineer. The design engineer may use stamped seal or embossed imprint; however, the embossed imprint must be shaded so that it will reproduce on prints.

N. A copy of the final plat for new development shall be included with the final design plans when submitted for final approval.

- O. If a roadway exists where plans are being prepared to improve or construct new pavement or a utility, label the existing roadway width, surfacing type, and thickness.
- P. Show all street and road alignments on plans.
- Q. Develop plans to accurate scale showing proposed pavement, typical cross sections, details, lines and grades, and existing topography within street right-of-way, and any easement contiguous with the right-of-way. At the intersection, the cross street details shall be shown at sufficient distance (20-foot minimum distance outside the primary roadway right-of-way) in each direction along cross street for designing adequate street crossings.
- R. Match lines between plan and profile sheets shall not be placed or shown within cross street intersections including cross street right-of-way.
- S. Show natural ground profiles as follows:
1. For privately-funded projects, centerline profiles are satisfactory except where a difference of 0.50 feet or more exists from one right-of-way or easement line to the other, in which case, dual profiles are required.
 2. For City projects, provide natural ground profiles for each right-of-way line. Easement profiles shall conform to Paragraph 3.04T.1.
- T. Basic plan and profile sheets shall contain the following information:
1. Identify lot lines, property lines, easements, rights-of-way, and HCFCD outfalls.
 2. Label each plan sheet as to street/easement widths, pavement widths, pavement thickness where applicable, type of roadway materials, curbs, intersection radii, curve data, stationing, existing utilities (type and location), and any other pertinent feature affecting design.
 3. Show utility lines 4 inches in diameter or larger within the right-of-way or construction easement in profile view. Show utility lines, regardless of size, in the plan view, including communication and fiber optic cables.
 4. Graphically show flow line elevations and direction of flow for existing ditches.
 5. Label proposed top of curb grades except at railroad crossings. Centerline grades are acceptable only for paving without curb and gutters.
 6. Show in profile curb return elevations for turnouts.
 7. Gutter elevations are required for vertical curves, where a railroad track is crossed.
 8. For street reconstruction projects, show in profile the centerline elevation at the property line of existing driveways.
 9. Show both existing and proposed station median noses or the centerline of

median openings, including median width.

10. The design of both roadways is required on paving sections with a median.
 11. Show in plan view station PCs, PTs, and radius returns. Show in profile station radius returns and grade change PIs with their respective elevations.
 12. All existing and proposed utilities and pavement shall be on the same plan and profile sheet for a given section unless approved otherwise by Project Manager.
 13. Plan view and profile view shall be on the same sheet whenever practical.
- U. For plant work, use a grid system to locate proposed work.

3.05 GRAPHIC STANDARDS

- A. The following graphic standards for plan and profile shall apply to plans of 1" = 20' scale. For smaller scale plans, use proportionally smaller line sizes.
- B. Existing Improvements: The standards shown in Figure 3.1, Existing Improvements, are required for depicting existing improvements on base plans. Use lower case letters with a No. 0 reprographic pen or equal line weight unless otherwise shown in the pen/line weight table, Figure 3.3, Line Code Definitions. Smaller pen sizes for lettering may be used for clarity.
- C. Proposed Improvements: The standards shown in Figure 3.2, Proposed Improvements, are required for depicting proposed improvements on base plans. Use upper case letters with a No. 3 reprographic pen or equal line weight unless shown otherwise in the pen/line weight table, Figure 3.3, Line Code Definitions. Smaller pen sizes for lettering may be used for clarity.
- D. Signature Block: Use latest edition of Signature Blocks issued by the Engineering and Construction Division for private and City projects.

END OF CHAPTER

FIGURE 3.1
EXISTING IMPROVEMENTS
PLAN VIEW

TEXT FOR EXISTING IMPROVEMENTS SHALL NOT BE SMALLER THAN 60 LEROY

		WT	LC
ROW LINE		3	0
PROPERTY LINE		3	0
THEORETICAL PROPERTY LINE		3	0
LOT LINES		1	0
EASEMENT LINE		0	2
CENTER LINE OF ROW		0	4
TRANSIT LINE		0	0
EDGE OF DITCHES		0	0
CENTER LINE OF DITCHES		0	2
EDGE OF DITCHES		0	0
FENCE LINE, WOOD		0	0
FENCE LINE, CHAIN LINK		0	0
FENCE LINE, BARBED WIRE		0	0
FENCE LINE, HOG WIRE		0	0
EDGE OF CONCRETE		0	0
CURB LINE		0	0
EDGE OF ASPHALT		0	0
EDGE OF SHELL OR GRAVEL		0	2
DIMENSION LINE		0	0
HL&P AERIAL LINE		0	0
HL&P UNDERGROUND LINE		0	6
GAS LINE		0	1
MISC UNDERGROUND LINES		0	8




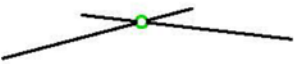
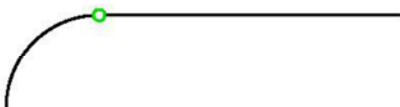




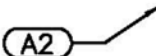
WT	LINE WEIGHT/WIDTH	METRIC
0	0.014"	0.35mm
1	0.020"	0.50mm
2	0.024"	0.60mm
3	0.031"	0.80mm
6	0.055"	1.40mm

LEGEND:

WT LINE WEIGHT
LC LINE CODE

**FIGURE 3.1 (CONTINUED)
EXISTING IMPROVEMENTS
PLAN VIEW**

TEXT FOR EXISTING IMPROVEMENTS SHALL NOT BE SMALLER THAN 60 LEROY

		WT	LC
PIPELINE OR WESTERN UNION CONDUIT	----- (IDENTIFY CONDUIT) -----	0	1
SWBT CONDUIT	-----  -----	0	2
CABLE TV	-----	0	2
MATCH LINE	-----	3	0
RAILROAD LINE		0	0
WATER LINE	----- 24" (AND SMALLER) WATER -----	0	7
	----- 30" (AND LARGER) WATER -----		
WASTEWATER SEWER LINE	----- 24" (AND SMALLER) WASTEWATER SEWER -----	0	3
	----- 30" (AND LARGER) WASTEWATER SEWER -----		
STORM SEWER LINE	----- 24" (AND SMALLER) STORM SEWER -----	0	0
	----- 30" (AND LARGER) STORM SEWER -----		
IRON PIPE OR IRON ROD MONUMENTS	-----  3/4" IP -----	0	0
POINT OF INTERSECTION (PI)		0	0
POINT OF CURVE (PC) POINT OF TANGENCY (PT)		0	0
POWER POLE		0	0
POWER POLE W/DOWN GUY		0	0
GAS METER	-----  -----	0	0
GAS VALVE	-----  -----	0	0
MISC UNDERGROUND PIPELINE LABEL		0	0









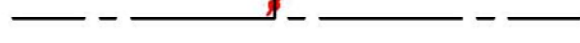



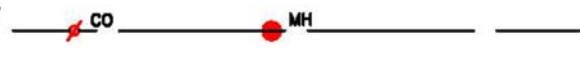

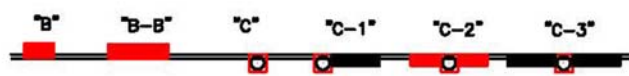
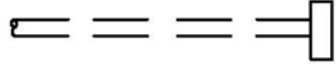
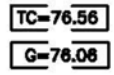
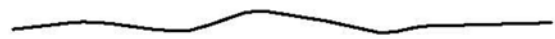
WT	LINE WEIGHT/WIDTH	METRIC
0	0.014"	0.35mm
1	0.020"	0.50mm
2	0.024"	0.60mm
3	0.031"	0.80mm
6	0.055"	1.40mm

LEGEND:

WT LINE WEIGHT
LC LINE CODE

**FIGURE 3.1 (CONTINUED)
EXISTING IMPROVEMENTS
PLAN VIEW**

TEXT FOR EXISTING IMPROVEMENTS SHALL NOT BE SMALLER THAN 60 LEROY

		WT	LC
PAVING HEADER		0	0
BUILDING, RESIDENTIAL		0	0
BUILDING COMMERCIAL		0	0
TREE		0	0
HEDGE		0	0
WATER METER		0	7
WATER VALVE (GATE)		0	7
WATER VALVE (BUTTERFLY)		0	7
FIRE HYDRANT/FLUSHING VALVE		0	7
TAPPING SLEEVE & VALVE		0	7
REDUCER		0	7
ROUND CONNECTION		0	7
WASTE WATER SEWER CLEANOUT AND MANHOLE		0	0
STORM SEWER MANHOLE		0	0
STORM SEWER INLETS		0	0
CULVERT PIPE ND HEADWALL		0	2
TOP OF CURB OR GUTTER LINE ELEV.		0	2
CONTOUR LINE		0	0

WT	LINE WEIGHT/WIDTH	METRIC
0	0.014"	0.35mm
1	0.020"	0.50mm
2	0.024"	0.60mm
3	0.031"	0.80mm
6	0.055"	1.40mm

LEGEND:

WT LINE WEIGHT
LC LINE CODE

FIGURE 3.1 (CONTINUED)
EXISTING IMPROVEMENTS
PROFILE VIEW

TEXT FOR EXISTING IMPROVEMENTS SHALL NOT BE SMALLER THAN 60 LEROY

		WT	LC
NORTH OR EAST PROPERTY LINE	-----	1	5
SOUTH OR WEST PROPERTY LINE	-----	1	6
NORTH OR EAST CURB	-----	1	7
SOUTH OR WEST CURB	-----	1	3
NORTH OR EAST DITCH	-----	1	7
SOUTH OR WEST DITCH	-----	1	3
NORTH OR EAST CULVERT	CULVERT	1	2
SOUTH OR WEST CULVERT	CULVERT	1	2
CENTERLINE OF ROW	-----	1	0
CENTERPOINT ENERGY CONDUIT	CENTERPOINT ENERGY CONDUIT	1	6
		1	0
GAS LINE	GAS LINE	1	1
		1	0
WESTERN UNION	WESTERN UNION	1	1
		1	0
AT & T CONDUIT	AT & T CONDUIT	1	2
		1	0
WATER LINE	WATER LINE 20" (AND SMALLER)	1	7
	WATER LINE 24" (AND LARGER)	1	0
		1	3
WASTEWATER SEWER LINE	SANITARY SEWER 24" (AND SMALLER)	1	0
	SANITARY SEWER 30" (AND LARGER)	1	3
		1	0
STORM SEWER LINE	STORM SEWER 24" (AND SMALLER)	1	0
	STORM SEWER 30" (AND LARGER)	1	0
		1	0

WT	LINE WEIGHT/WIDTH	METRIC
0	0.014"	0.35mm
1	0.020"	0.50mm
2	0.024"	0.60mm
3	0.031"	0.80mm
6	0.055"	1.40mm

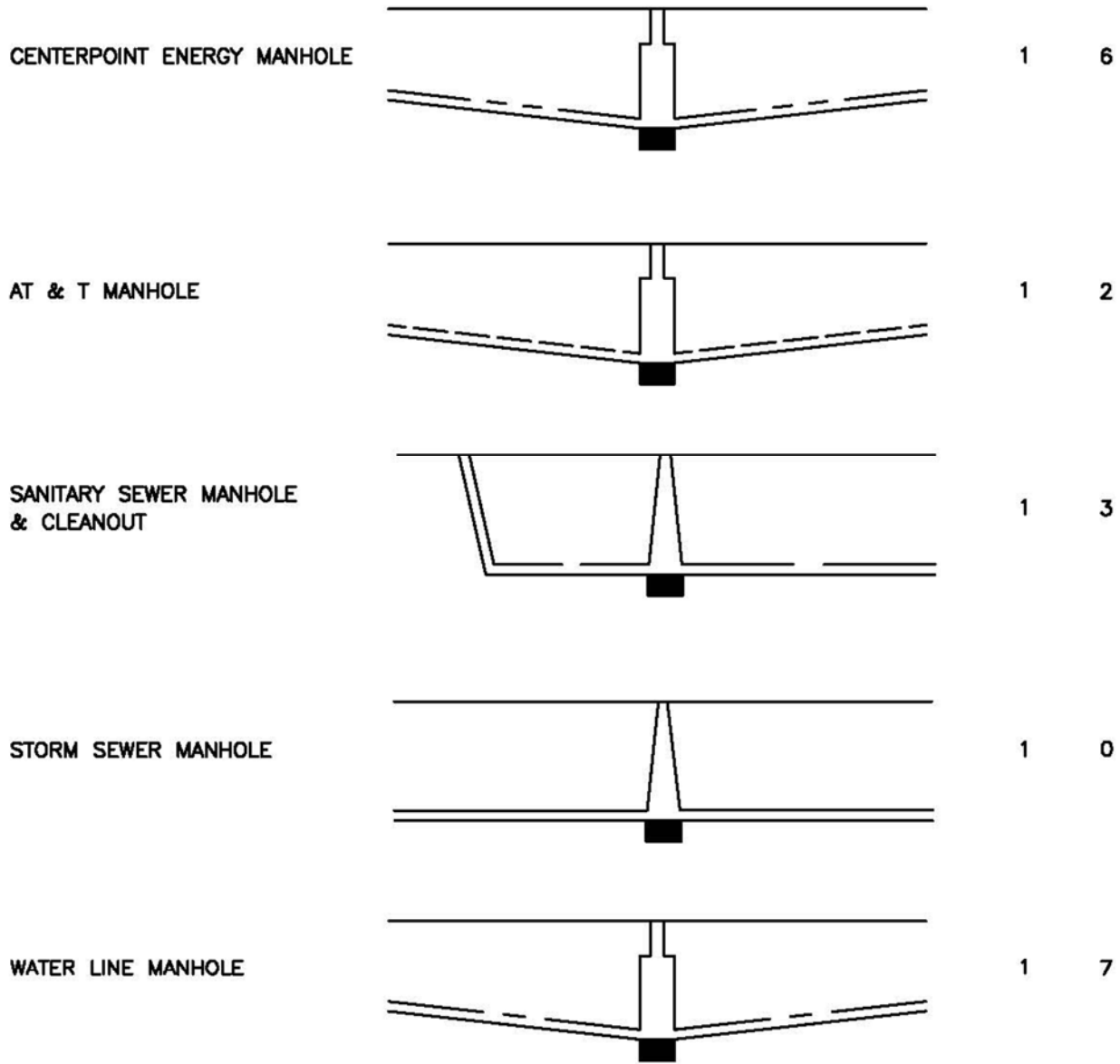
LEGEND:

WT LINE WEIGHT
LC LINE CODE

FIGURE 3.1 (CONTINUED)
EXISTING IMPROVEMENTS
PROFILE VIEW

TEXT FOR EXISTING IMPROVEMENTS SHALL NOT BE SMALLER THAN 60 LEROY

WT LC



WT	LINE WEIGHT/WIDTH	METRIC
0	0.014"	0.35mm
1	0.020"	0.50mm
2	0.024"	0.60mm
3	0.031"	0.80mm
6	0.055"	1.40mm

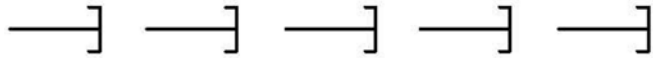
LEGEND:

WT	LINE WEIGHT
LC	LINE CODE

FIGURE 3.1 (CONTINUED)

PLAN VIEW

S.S. FORCE MAIN



RECLAIMED WL

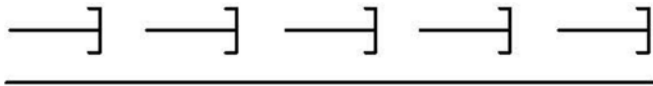


NON-POTABLE WL



PROFILE VIEW

S.S. FORCE MAIN



RECLAIMED WL



NON-POTABLE WL

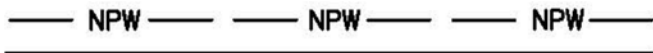
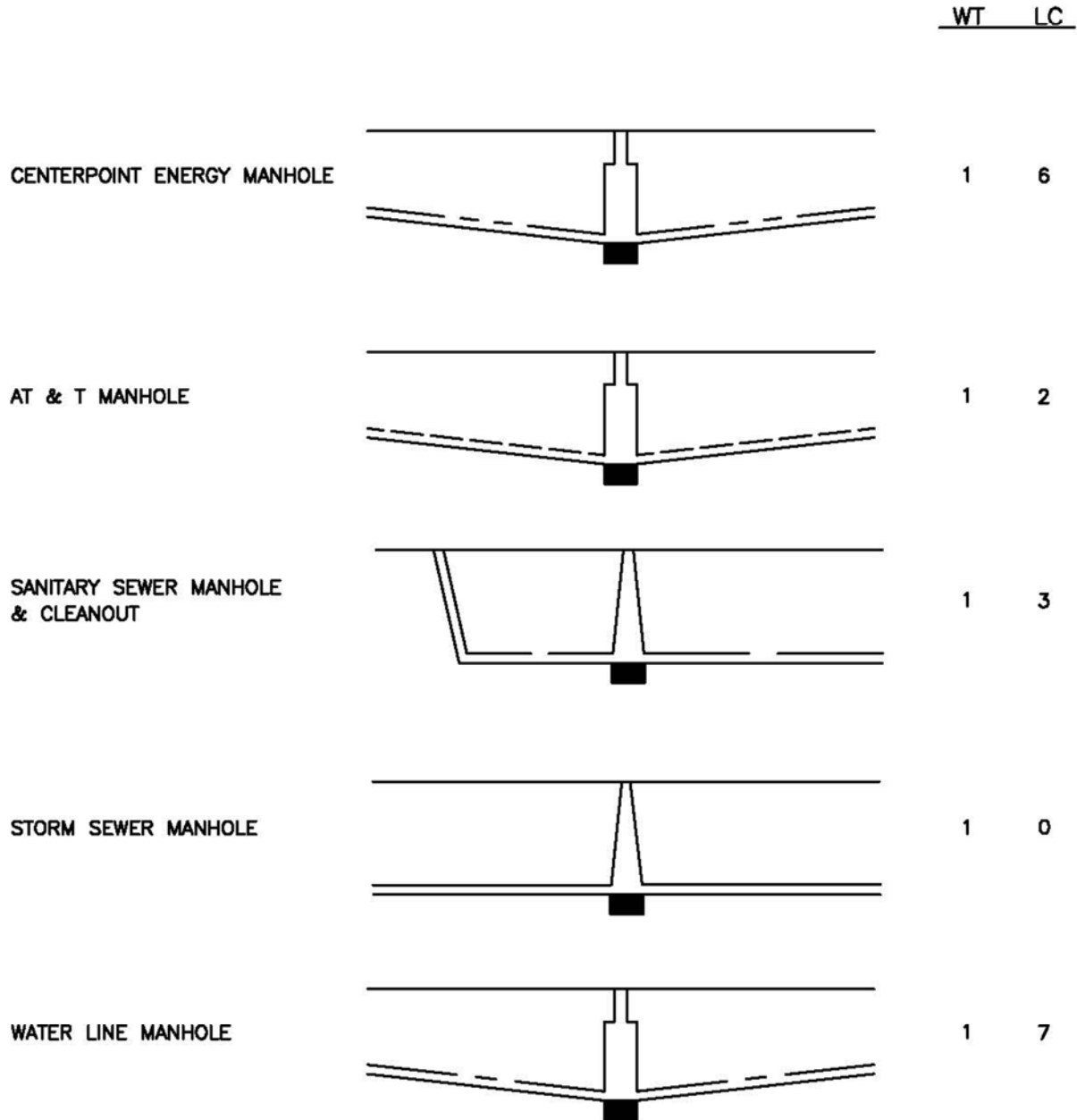


FIGURE 3.1 (CONTINUED)
EXISTING IMPROVEMENTS
PROFILE VIEW

TEXT FOR EXISTING IMPROVEMENTS SHALL NOT BE SMALLER THAN 60 LEROY



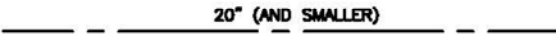
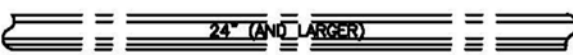
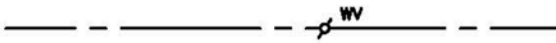
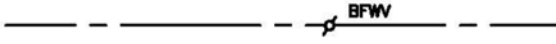
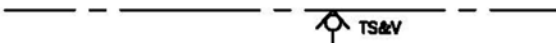

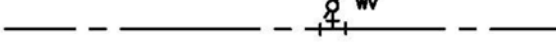
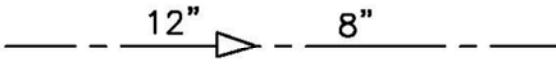
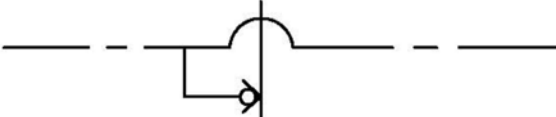
WT	LINE WEIGHT/WIDTH	METRIC
0	0.014"	0.35mm
1	0.020"	0.50mm
2	0.024"	0.60mm
3	0.031"	0.80mm
6	0.055"	1.40mm

LEGEND:

WT	LINE WEIGHT
LC	LINE CODE

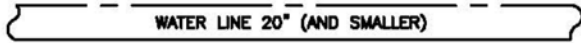
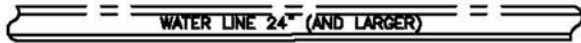
FIGURE 3.2
 PROPOSED IMPROVEMENTS – WATER LINES
 PLAN VIEW

TEXT FOR PROPOSED IMPROVEMENTS SHALL NOT BE SMALLER THAN 100 LEROY

		WT	LC
WATER LINE	 20" (AND SMALLER)	3	7
	 24" (AND LARGER)	3	7
WATER VALVE (GATE)	 WV	3	7
WATER VALVE (BUTTERFLY)	 BFWV	3	7
TAPPING SLEEVE & VALVE	 TS&V	3	7
	 FHY/FV	3	7
FIRE HYDRANT/FLUSHING VALVE	 WV	3	7
REDUCER	 12" 8"	3	7
ROUND CONNECTION		3	7

PROPOSED IMPROVEMENTS – WATER LINES
 PROFILE VIEW

TEXT FOR PROPOSED IMPROVEMENTS SHALL NOT BE SMALLER THAN 100 LEROY

		WT	LC
WATER LINE	 WATER LINE 20" (AND SMALLER)	3	7
	 WATER LINE 24" (AND LARGER)	3	7

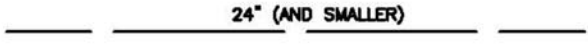

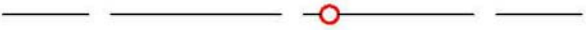
WT	LINE WEIGHT/WIDTH	METRIC
0	0.014"	0.35mm
1	0.020"	0.50mm
2	0.024"	0.60mm
3	0.031"	0.80mm
6	0.055"	1.40mm

LEGEND:

WT LINE WEIGHT
 LC LINE CODE

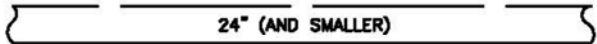

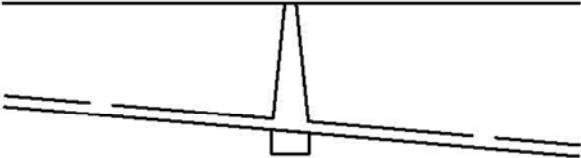
FIGURE 3.2 (CONTINUED)
 PROPOSED IMPROVEMENTS – SANITARY SEWER LINES
 PLAN VIEW

TEXT FOR PROPOSED IMPROVEMENTS SHALL NOT BE SMALLER THAN 100 LEROY

	<u>WT</u>	<u>LC</u>
SANITARY SEWER LINE	 <p style="text-align: center; margin: 0;">24" (AND SMALLER)</p>	3 3
	 <p style="text-align: center; margin: 0;">30" (AND LARGER)</p>	3 3
MANHOLE		3 3

PROPOSED IMPROVEMENTS – SANITARY SEWER LINES
 PROFILE VIEW

TEXT FOR PROPOSED IMPROVEMENTS SHALL NOT BE SMALLER THAN 100 LEROY

	<u>WT</u>	<u>LC</u>
SANITARY SEWER LINE	 <p style="text-align: center; margin: 0;">24" (AND SMALLER)</p>	3 3
	 <p style="text-align: center; margin: 0;">30" (AND LARGER)</p>	3 3 0 0
MANHOLE		3 3 3 0



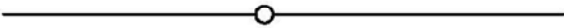
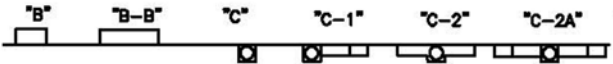
WT	LINE WEIGHT/WIDTH	METRIC
0	0.014"	0.35mm
1	0.020"	0.50mm
2	0.024"	0.60mm
3	0.031"	0.80mm
6	0.055"	1.40mm

LEGEND:

WT LINE WEIGHT
 LC LINE CODE



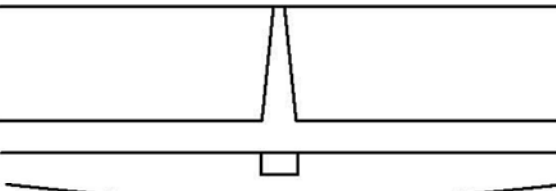

FIGURE 3.2 (CONTINUED)
 PROPOSED IMPROVEMENTS – STORM SEWER LINES
 PLAN VIEW

TEXT FOR PROPOSED IMPROVEMENTS SHALL NOT BE SMALLER THAN 100 LEROY

	WT	LC
STORM SEWER LINES	 <p style="text-align: center; margin: 0;">24" (AND SMALLER)</p>	3 0
	 <p style="text-align: center; margin: 0;">30" (AND LARGER)</p>	3 0
MANHOLE		3 0
INLETS		3 0

PROPOSED IMPROVEMENTS – STORM SEWER LINES
 PROFILE VIEW

TEXT FOR PROPOSED IMPROVEMENTS SHALL NOT BE SMALLER THAN 100 LEROY

	WT	LC
STORM SEWER LINES	 <p style="text-align: center; margin: 0;">24" (AND SMALLER)</p>	3 0
	 <p style="text-align: center; margin: 0;">30" (AND LARGER)</p>	3 0
MANHOLE		3 0
INLETS		3 0



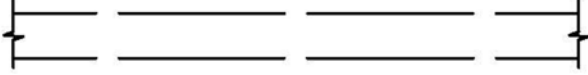
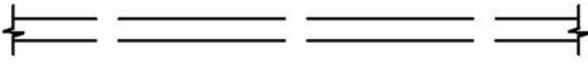
WT	LINE WEIGHT/WIDTH	METRIC
0	0.014"	0.35mm
1	0.020"	0.50mm
2	0.024"	0.60mm
3	0.031"	0.80mm
6	0.055"	1.40mm

LEGEND:

WT	LINE WEIGHT
LC	LINE CODE

FIGURE 3.2 (CONTINUED)
 PROPOSED IMPROVEMENTS – PAVEMENTS
 PLAN VIEW

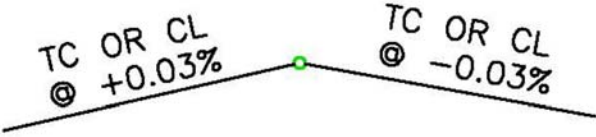
TEXT FOR PROPOSED IMPROVEMENTS SHALL NOT BE SMALLER THAN 100 LEROY

	<u>WT</u>	<u>LC</u>
FACE OF CURB 	6	3
EDGE OF PAVEMENT 	6	0
CONCRETE WALK 	3 2 3	3 0 3
CONCRETE HEADER 	3	3
TOP OF CURB OR GUTTER LINE ELEVATION	2	0

TC=76.56
G=76.06

PROPOSED IMPROVEMENTS – PAVEMENTS
 PROFILE VIEW

TEXT FOR PROPOSED IMPROVEMENTS SHALL NOT BE SMALLER THAN 100 LEROY

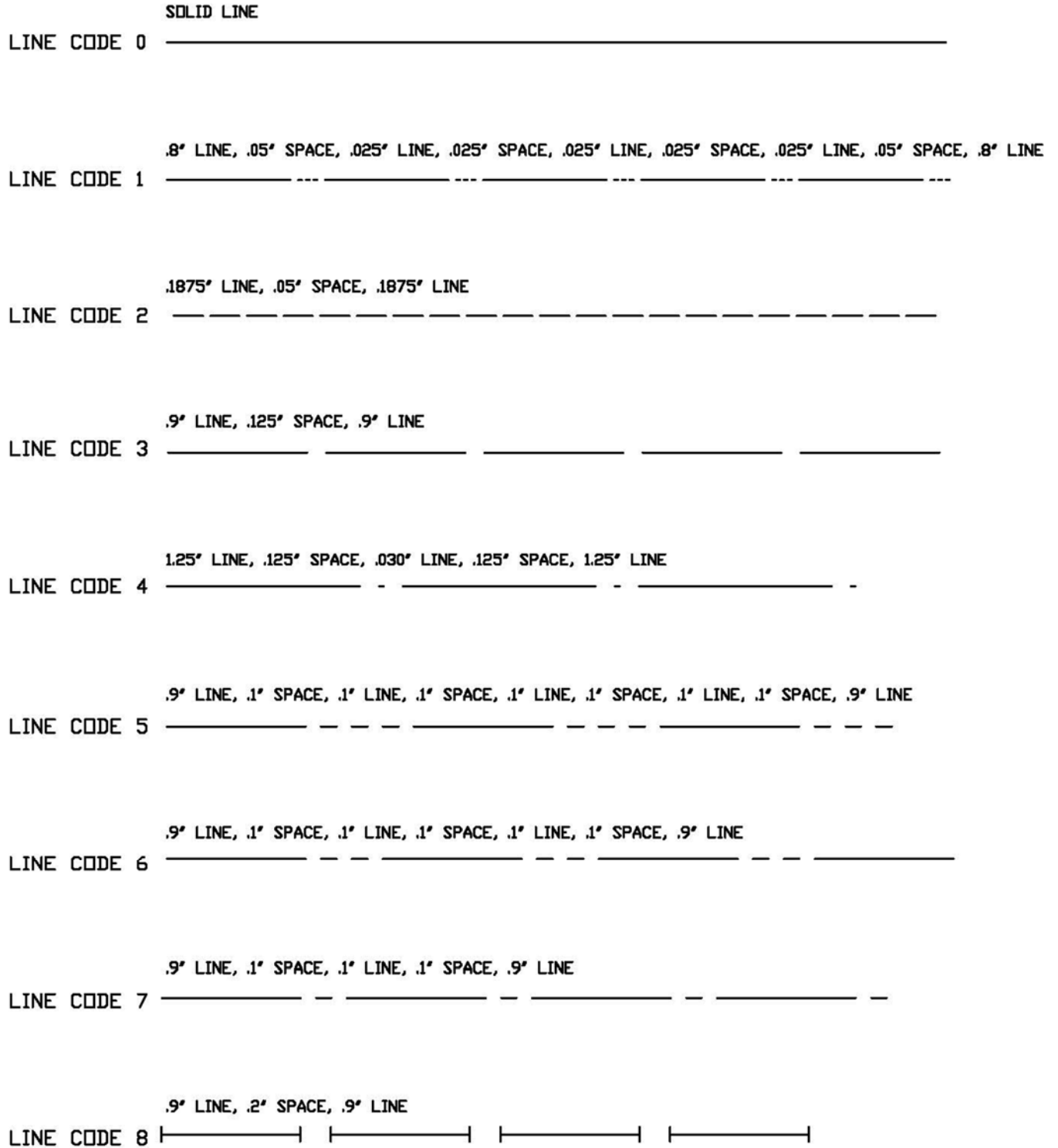
	<u>WT</u>	<u>LC</u>
TOP OF CURB OR CENTERLINE FOR OPEN DITCH PAVING	2	3
	3	0

WT	LINE WEIGHT/WIDTH	METRIC
0	0.014"	0.35mm
1	0.020"	0.50mm
2	0.024"	0.60mm
3	0.031"	0.80mm
6	0.055"	1.40mm

LEGEND:

WT LINE WEIGHT
 LC LINE CODE

FIGURE 3.3
 LINE CODE DEFINITIONS
 ALL LENGTHS IN INCHES



Appendix D

CONSTRUCTION NOTES TO BE ON ALL PROJECTS	
NO	DESCRIPTION OF ITEM
1	Water lines, wastewater collection systems, and storm drainage systems shall be designed and constructed in accordance with the CITY OF HOUSTON’S, DEPARTMENT OF PUBLIC WORKS AND ENGINEERING “DESIGN MANUAL, STANDARD CONSTRUCTION SPECIFICATIONS, AND DETAILS FOR WASTEWATER COLLECTION SYSTEMS, WATER LINES, STORM DRAINAGE AND STREET PAVING” .
2	All storm sewer will be reinforced concrete (C76 Class III) and shall be installed, bedded and backfilled in accordance with the City of Houston’s Drawings 02317-02, 02317-03, 02317-05, 02317-06 and 02317-07 as applicable.
3	All storm sewers constructed in side lot easements shall be R.C.P., minimum twenty (20) foot wide easements shall be provided.
4	An alternative to cement stabilized sand may be used as backfill for pipes fifty-four (54) inch and larger, from 1-foot above the top of the pipe to the bottom of the subgrade. Contractor may backfill with suitable material, provided the backfill material is placed in eight (8) inch lifts and mechanically compacted to ninety-five (95)% standard proctor density. Tests shall be taken at one hundred (100) foot intervals on each lift. Bedding and backfill to one (1) foot above the top of the pipe shall be cement-stabilized sand.
5	All proposed pipe stub-outs from manholes or inlets are to be plugged with eight (8) inch brick walls unless otherwise noted.
6	The contractor(s) shall notify Harris County Engineering Department – Permit Office twenty-four (24) hours in advance of commencing utility and/or paving construction at (713) 274-3823 and written notification forty-eight (48) hours in advance of commencing construction at 10555 Northwest Freeway, Suite 144, Houston, TX 77092.
7	Paving shall be in accordance with the “Regulations of Harris County, Texas for the Approval and Acceptance of Infrastructure” and/or amendments of the same.
8	Guidelines set forth in the latest edition of the “Texas Manual on Uniform Traffic Control Devices, TMUCD with Revisions” shall be observed.
9	OWNER OR OWNER’S AGENT to obtain all permits required by the “Regulations of Harris County, Texas for Floodplain Management” prior to starting construction.
10	OWNER OR OWNER’S AGENT to obtain all notifications required by Harris County, Texas prior to starting construction of utilities and/or culverts within Harris County and Harris County Flood Control District Rights-of-Way.
PLEASE ADD ALL NOTES CIRCLED IN RED TO THE CONSTRUCTION PLANS.	

Appendix E

CONSTRUCTION NOTES INVOLVING UTILITIES AND PAVING WORK LOCATED WITHIN A PUBLIC RIGHT-OF-WAY	
NO	DESCRIPTION OF ITEM
1	<p>NOTE: “Notifications Issued by Harris County Engineering Department - Permits Office - is required for proposed work within Harris County Right-of-Way. The project must be approved prior to obtaining the required Notification. Be advised that a Notification must be obtained separately from site development permit package. For additional information, please visit http://www.eng.hctx.net/permits/Public-Review-Code/Public-Plan-Review/Notification-of-Construction-in-the-ROW or contact Public Review Inspections Department @ (713-274-3931)”</p>

Appendix F

CONSTRUCTION NOTES FOR ESPLANADE OPENINGS AND TURN LANES	
NO	DESCRIPTION OF ITEM
1	Esplanade noses at the crossover are to be bullet type, painted reflectorized yellow, in accordance with the Harris County Pavement Marking Detail and to be six inches (6”) thick with surface colored black for concrete pavement and uncolored for asphalt pavement, a minimum of six feet (6’) deep measured from the end of the median nose and the curbs are at least four feet (4’) in width face to face.
2	The relocation of existing trees, landscaping, sprinkler systems, water meters, fire hydrants, manholes, and pipelines (if applicable) are to be re-installed as recommended by the Harris County Engineering Department - Permit Office and/or the Harris County Precinct (If located in Precinct 3, add note: Contractor(s) to contact Precinct 3 Parks Administration Office @ (281-531-1592) two (2) weeks prior to construction for tree(s) and landscaping relocation.
3	Existing reinforced concrete pavement is to be machine saw-cut 1-1/2 inches deep to expose a minimum of twenty-four (24) inches of reinforcing bars and place new reinforcing bars to match existing steel size and spacing and tie new reinforcing bars to existing reinforcing bars with eighteen (18) inch laps. Full depth saw-cut may be used as an alternative.
4	Reinforcing concrete pavement is to be a minimum eight (8) inches with a minimum of 5.0 sack cement per cubic yard, [4500 psi in twenty-eight (28) days]. Note: Depth of concrete to meet current requirements of depth of existing pavement whenever it is greater.
5	Asphalt turn lane to be minimum (2) inches H.M.A.C. with (10) inch base. Road widening’s done on asphalt roadways for turn lanes must be overlaid full width of the roadway from beginning to ending transition.
6	Subgrade shall be a minimum of six (6) inches for asphalt and eight (8) inches for concrete, of a material as specified by the engineer and approved by Harris County, and compacted to ninety-five (95) percent standard proctor density (+/-) two (2) percent moisture. Cement stabilized sand, as prescribed by Harris County specs, may be used as an alternative.
7	Slope on proposed concrete left turn slots is to be a minimum of 1/8 inch per foot with crown at center of esplanade.
8	All sewers under or within one (1) foot of proposed or future pavement shall be backfilled with 1-1/2 sack cement stabilized sand to within one (1) foot of subgrade.
9	The contractor shall notify the Harris County Engineering Department - Permit Office twenty-four (24) hours in advance of commencing construction at (713) 274-3931 and written notification forty-eight (48) hours in advance of commencing construction for commercial and residential development.

Appendix F

CONSTRUCTION NOTES FOR ESPLANADE OPENINGS AND TURN LANES	
NO	DESCRIPTION OF ITEM
10	All pavement work will require an accredited lab certification for subgrade, concrete compressive strength, in place core. Asphalt work will require a sieve test, subgrade and base compaction results.
11	Paving shall be in accordance with the “Regulations of Harris County, Texas for the Approval and Acceptance of Infrastructure” relating to the approval and acceptance of improvements in subdivisions or re-subdivisions and/or amendments of the same.
12	Guidelines set for in the “Manual on Uniform Traffic Control Devices” shall be observed.
13	Include Harris County Drawing SD-1 as part of the construction plans.
14	Include Harris County Pavement Marking Detail as a part of the construction plans.
15	NOTE: “Notification(s) issued by Harris County Engineering Department - Permit Office required prior to construction of utilities or turn lanes within Harris County rights-of-way”. Contact Harris County Permit Office at (713) 274-3931.
16	OWNER OR OWNER’S AGENT to obtain all permits and notification(s) required by Harris County, Texas prior to starting construction of utilities and/or culverts within Harris County road rights-of-way.
PLEASE ADD ALL NOTES CIRCLED IN RED TO THE CONSTRUCTION PLANS.	

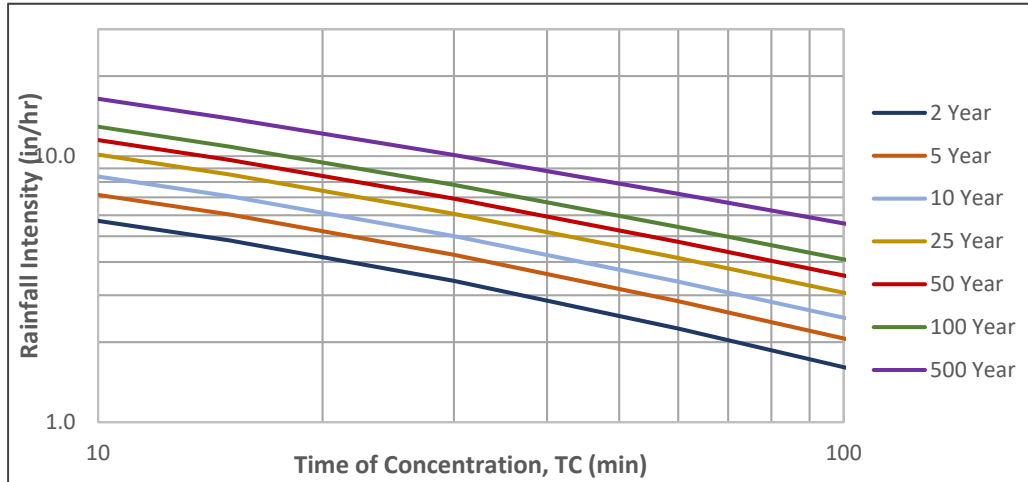
Appendix G

**CONSTRUCTION NOTES FOR ALL
PROJECTS LOCATED IN THE 1% (100-YEAR) FLOODPLAIN AND .2%
(500-YEAR) FLOODPLAIN**

CONSTRUCTION NOTES FOR ALL PROJECTS LOCATED IN THE 1% (100-YEAR) FLOODPLAIN AND .2% (500-YEAR) FLOODPLAIN		
NO		DESCRIPTION OF ITEM
1		All proposed construction shall be in accordance with the "Regulations of Harris County, Texas for Floodplain Management".
2		OWNER OR OWNER'S AGENT to obtain all permits required by Harris County, Texas prior to starting development within Harris County and Harris County road rights-of-way.

Appendix H

Intensity Duration Curves



Region 3*

*Regions can be found in the Harris County Flood Control District Policy, Criteria, and Procedure Manual Reference Section 6.02.1.B. for design requirements.

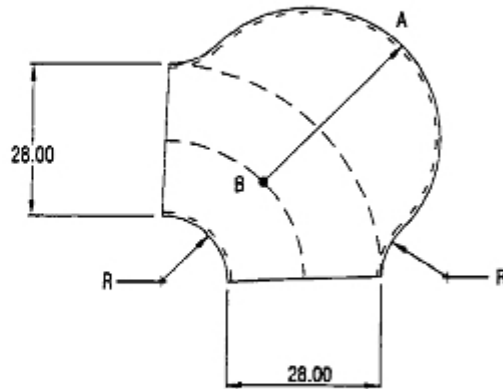
$$\text{Intensity, } i = \frac{b}{(d + TC)^e}$$

Coefficient	50 % AEP	20 % AEP	10 % AEP	4 % AEP	2 % AEP	1 % AEP	0.2 % AEP
	2-Year	5-Year	10-Year	25-Year	50-Year	100-Year	500-Year
<i>Region 3</i>							
e	0.7244	0.6900	0.6623	0.6294	0.6096	0.5797	0.5196
b (in.)	48.35	52.32	54.68	57.79	61.00	60.66	62.17
d (min.)	9.07	7.88	6.96	5.89	5.46	4.44	2.95

AEP - annual exceedance probability

Appendix I

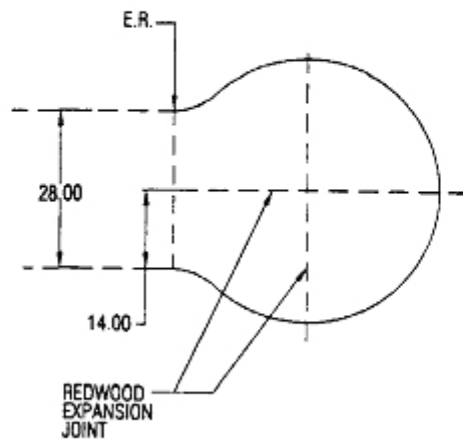
JOINT DETAIL FOR : KNUCKLE CONFIGURATION



NOTES:

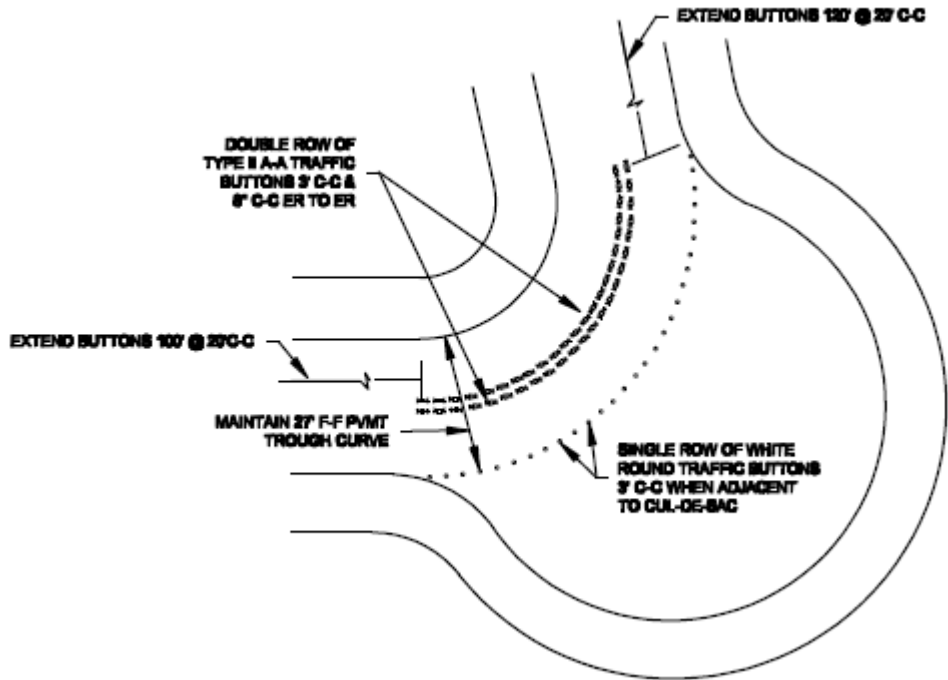
1. REDWOOD EXPANSION JOINT REQUIRED BETWEEN POINT A AND B.
2. ADDITIONAL EXPANSION JOINTS OR CONTRACTION JOINTS ARE NOT ACCEPTABLE.

JOINT DETAIL FOR : TYPICAL CUL-DE-SAC



- NOTES:
ADDITIONAL EXPANSION OR
CONTRACTION JOINTS ARE NOT
ACCEPTABLE.

Button Detail For: Knuckle Configuration



Appendix J

Benchmark Requirements

Standards

New benchmarks are required to use the same criteria established during the Tropical Storm Allison Recovery Project. The mark will be established using NAVD 1988, 2001 Adjustment Elevation and the GEOID 99 ellipsoid model to match the current Flood Insurance Rate Map effective June 18, 2007.

Use as much as possible dual frequency, full-wavelength Global Positioning System (GPS) receivers. The National Geodetic Survey (NGS) 2-centimeter standard, as published in NOAA Technical Memorandum NOS NGS-58 dated November 1997 is the vertical surveying standard. The horizontal standard is the NGS Second Order Class I standard as published in the Federal Geodetic Control Committee (FGCC) document entitled "Geometric Geodetic Accuracy Standards and Specifications for Using GPS Relative Positioning Techniques" dated August 1, 1989. In areas where it is impossible to use GPS due to conditions such as obstructed sky visibility, precise differential leveling is required to connect such obstructed benchmarks to the rest of the network. Differential leveling will be used to meet the maximum loop misclosure specifications for the NGS Second Order Class II vertical stand for leveling, as published in the FGCC document entitled "Standards and Specifications for Geodetic Control Networks" dated September 1984.

The control will meet the NGS Classification system for Range VI positions. Range VI indicates that these positions meet the 0.02 meter 0 0.05 meter Accuracy Standard for Horizontal Position, Ellipsoidal Height, and Orthometric Height (elevation) and the 95% confidence level.

Survey Control

The controls to be used are the Continuously Operating Reference Stations (CORS) monitored by NGS. The CORS stations located at extensometer sites are constructed so as to be unaffected by the subsidence of the ground around them. They are considered by HGCSD and others to be the most stable control monuments in Harris County. The three CORS sites are as follows:

PID AJ6426 ADDICKS 1795 CORS ARP (ADKS)

PID AJ6430 NORTHEAST 2250 CORS ARP (NETP)

PID AF9521 LAKE HOUSTON CORS ARP (LKHU)

PID = Permanent Identifier

ARP = Antenna Reference Point (physical bottom of the antenna)

The 1997.00 Epoch Date will be referenced to coincide with the existing network.

Benchmark Construction

A brass disk, provided by Harris County Flood Control District, shall be set in a drilled hole in the concrete on a permanent structure and fastened with epoxy cement or established as a permanent monument. A Reference Mark Number will be assigned to your new monument. Stamp the new disk with the newly assigned Reference Mark Number.

Benchmark Acceptance

Reference Mark submittal forms can be obtained from the Harris County Permits Office or downloaded from the website, <http://www.eng.hctx.net/permits>. A Texas State Registered Professional Land Surveyor is required to set, level and submit for acceptance new benchmarks. Submit two (2) paper copies and the digital file of the fully completed forms to the Harris County Permits Office. After acceptance, the benchmark information will be uploaded to the Harris County benchmark website for public use.

APPENDIX K

UNIFORM STANDARDS FOR PUBLIC STREET NAMING

This appendix is written to provide clarification to the street naming standards in Harris County. Uniformity in street name selection is essential to public safety as it reduces confusion to the general traveling public, and most importantly reduces confusion to the emergency service providers.

PRINCIPLES:

Public street naming shall follow these principles:

1. Named in a manner that reduces confusion to the traveler, utility providers, addressing authority, and most importantly the emergency service provider.
2. When located within, or partially within a Municipality or its Extraterritorial Jurisdiction (ETJ), street name selection shall follow the guidelines for naming streets enacted by that Municipality.
3. “One Street – One Name Principle” - Maintains the same name for the entire limits of the street.
 - a. When presented the opportunity through a street limit extension or other improvements, the County Engineer will, when able, require street name uniformity for the entire limits of the street where it does not currently exist.
 - b. Regardless of planned improvements, if at any point a safety concern is discovered due to non-uniformity, the County Engineer may recommend changing the street name to facilitate uniformity and safety.
4. All steps necessary to change a street name will be executed by the applicant.

GUIDELINES:

In general, to meet the three principles outlined above, the following are guidelines for naming streets within Harris County:

1. A new street that is an extension of an existing street or master planned street shall have the same name as the existing street.
2. A non-public street that is a direct extension of a public street or a cul-de-sac shall not have the same name as the public street.
3. A directional prefix or suffix may be used to clarify the general location of a street, provided that the use of the directional prefix or suffix is consistent with the established naming convention within the area in which the street exists.
4. Street name suffixes shall be limited to the following uses:
 - a. “Circle”, “Court” and “Loop” shall be used only to designate streets that terminate at a cul-de-sac or are configured as a geometrically looped street.
 - b. “Boulevard”, “Crossing”, “Crossroad”, “Expressway”, “Motorway”,

“Parkway”, “Speedway” or “Throughway” shall be used only to designate major thoroughfares, major collector streets, collector streets or other streets designed to handle traffic volumes in excess of normal neighborhood traffic generation or that are boulevard sections (i.e. median divided) with at least two lanes of traffic in each direction.

- c. “Bypass”, “Expressway”, “Freeway” and “Highway” shall be used only to designate highway or freeways subject to jurisdiction of the state department of transportation.
 - d. “Avenue”, “Drive”, “Road”, and “Street” shall be used only to designate major thoroughfares, major collector streets, collector streets, or local streets.
 - e. “Bridge”, “Fork”, “Lane”, “Oval”, “Passage”, “Path”, “Place”, “Trail” and “Way” shall be used only to designate collector streets or local streets.
 - f. “Tunnel” shall be used only to designate streets that provide underground or underwater passage.
 - g. A street name suffix shall not be used as part of the street name.
 - h. The abbreviation of a street name suffix shall be consistent with the United States Postal Service postal addressing standards.
5. A street name shall not include any typographic characters or symbols.
 6. An alphabetical or numerical street name shall not be used to name a new street unless the new street is a direct extension of an existing street with an alphabetical or numerical name that is not duplicative of an existing street name.
 7. When a street changes horizontal direction by approximately 90 degrees, the street name shall change.

For purposes of the section, the terms cul-de-sac, collector street, and local street shall have the meanings assigned to those terms by the Federal Highway Administration (FHWA) and/or American Association of State Highway and Transportation Officials (AASHTO) “A Policy on Geometric Design of Highway and Streets”.

EXEMPTIONS

For streets located in an Extraterritorial Jurisdiction of a municipality, the County Engineer will review requests for exceptions only after written approval for the exception from the Municipality is obtained by the applicant. In locations without Extraterritorial Jurisdiction, requests for exceptions will follow the procedures outlined within the Harris County Infrastructure Regulations.